

CE

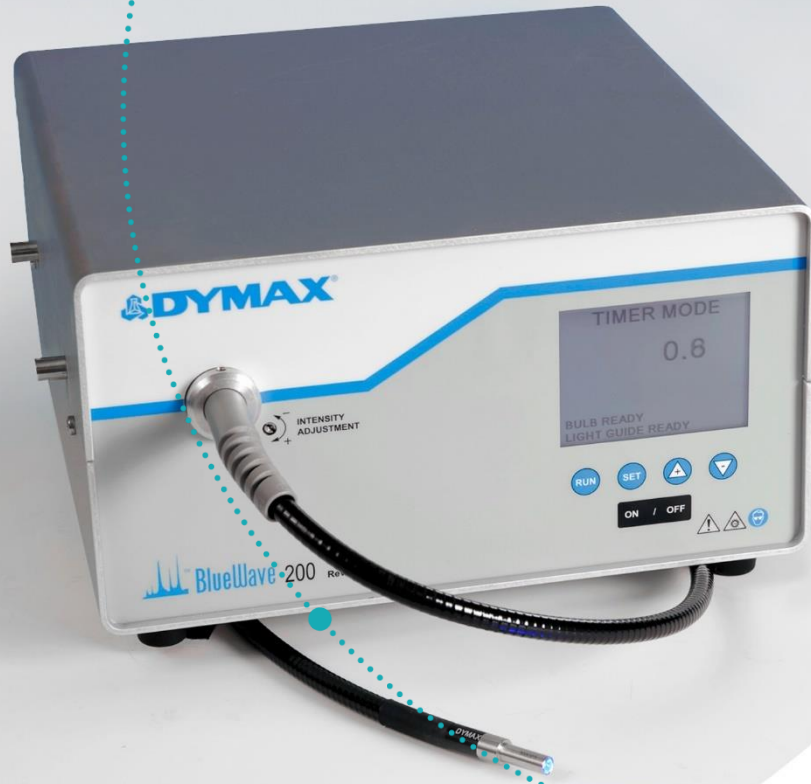

BlueWave[®] 200 Version 3.0

UV Light-Curing Spot Lamp User Guide

 **DYMAX[®]**

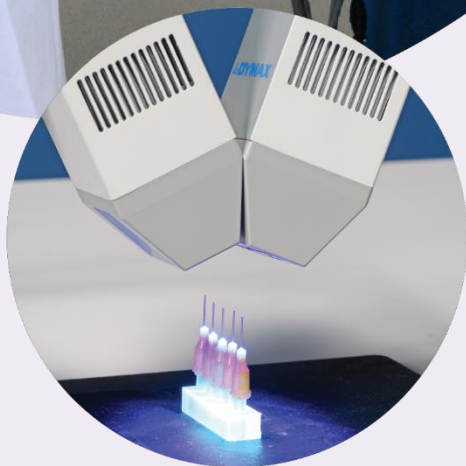

About Dymax

UV/Visible light-curable adhesives. Systems for light curing, fluid dispensing, and fluid packaging.

Dymax manufactures industrial, light-curable, epoxy, and activator-cured adhesives. We also manufacture a complete line of manual fluid dispensing systems, automatic fluid dispensing systems, and light-curing systems. Light-curing systems include LED light sources, spot, flood, and conveyor systems designed for compatibility and high performance with Dymax adhesives.

Dymax adhesives and light-curing systems optimize the speed of automated assembly, allow for 100% in-line inspection, and increase throughput. System designs enable stand-alone configuration or integration into your existing assembly line.

Please note that most dispensing and curing system applications are unique. Dymax does not warrant the fitness of the product for the intended application. Any warranty applicable to the product, its application, and use is strictly limited to that contained in the Dymax standard Conditions of Sale. Dymax recommends that any intended application be evaluated and tested by the user to ensure that desired performance criteria are satisfied. Dymax is willing to assist users in their performance testing and evaluation by offering equipment trial rental and leasing programs to assist in such testing and evaluations. Data sheets are available for valve controllers or pressure pots upon request.

Contents

Introduction.....	5
Where to Get Help.....	5
Safety.....	5
General Safety Considerations.....	5
Specific Safety Considerations.....	5
Dymax UV Light-Curing System Safety Considerations	5
Product Overview	7
Unpacking the BlueWave 200.....	8
Unpacking and Inspecting Your Shipment.....	8
Parts List.....	8
Setting Up the BlueWave 200	9
Becoming Familiar with the Controls.....	10
Turning the BlueWave 200 On.....	11
Setting an Operating Mode.....	12
Introduction to Operating Modes	12
Choosing an Operating Mode.....	12
Operating in Manual Mode.....	16
Manual Mode Description	16
Procedure.....	16
Operating in Timer Mode	17
Timer Mode Description	17
Procedure to Adjust Timer	17
Operating in PLC Mode	18
PLC Mode Description.....	18
Start-Up Screen for PLC Mode	18
Using the PLC Switch	18
Wiring the PLC Interface	21
PLC Front Panel Emergency Stop	24
Troubleshooting the PLC Interface	24
Setting the Intensity	25
Setting Up the Curing Process	25
Methods.....	25
Maintaining Process Control.....	25

Maintaining the <i>BlueWave 200</i>	25
Bulb Replacement Warning	25
Bulb Replacement Procedure.....	26
Lightguide.....	27
Fan Filter.....	27
Fuse Replacement.....	27
System Cleaning.....	27
Solving Problems	28
Troubleshooting.....	28
.....	28
Frequently Asked Questions.....	29
Diagnostic Display	30
Spare Parts and Accessories	31
Spare/Replacement Parts	31
Options/Accessories	31
Specifications	32
Declaration of Conformity	33
Definition of Terms	34
Warranty	34
Replacement Bulb Warranty	34
Index	35

Introduction

This guide describes how to assemble, use, and maintain the BlueWave® 200 Rev. 3.0 light-curing spot lamp system safely and efficiently. Dymax prepared this user guide for experienced process engineers, technicians, and manufacturing personnel. If you are new to UV light-curing equipment and do not understand the instructions, contact Dymax Application Engineering to answer your questions before using the equipment.

Where to Get Help

Dymax Customer Support and Application Engineering teams are available in the United States, Monday through Friday, from 8:00 a.m. to 5:30 p.m. Eastern Standard Time. You can also email Dymax at info@dymax.com. Contact information for additional Dymax locations can be found on the back cover of this user guide.

Additional resources are available to ensure a trouble-free experience with our products:

- Detailed product information on www.dymax.com
- Dymax adhesive Product Data Sheets (PDS) on our website
- Safety Data Sheets (SDS) provided with shipments of Dymax adhesives

Safety



WARNING! If you use this UV light-curing system without first reading and understanding the information in this user guide, injury can result from exposure to high-intensity UV light. To reduce the risk of injury, read and ensure you understand the information in this user guide before assembling and operating the Dymax BlueWave spot lamp.

To use this system safely, it must be set up and operated in accordance with the instructions given by Dymax. Using the system in any other manner will impair the protection of the system. Dymax assumes no liability for any changes that may impair the protection of the system.

General Safety Considerations

All users of Dymax light-curing systems should read and understand this user guide before assembling and using the system.

To learn about the safe handling and use of light-curable formulations, obtain and read the SDS for each product. Dymax includes an SDS with each adhesive sold. In addition, fluid product SDS can be requested on our website.

Specific Safety Considerations

The BlueWave 200 is designed to maximize operator safety and minimize exposure to UV light. To use the BlueWave 200 safely, it must be set up and operated in accordance with the instructions in this user guide. Please also read and understand the safety considerations unique to UV light-curing systems.



CAUTIONS & WARNINGS! To prevent eye injury from ultra-violet energy, always wear UV-blocking protective goggles or a face shield when working with or near the BlueWave 200. Long-sleeved shirts or a lab coat are also recommended to protect the arms and use of UV-opaque gloves will protect the hands.



With the internal filter installed, the BlueWave 200 emits UVA and visible light. Never look directly at the light source while the unit is on.

Always observe safety requirements.

There is risk of electrical shock if cover is removed.



Cover is warm to the touch when the system is in operation.

Dymax UV Light-Curing System Safety Considerations

Operators must understand these four concepts to use the UV light-curing system safely: UV exposure, high-temperature surfaces, ozone, and bright, visible light. Each is described in the following sections.

UV Exposure

Standard Dymax UV light-curing systems and bulbs have been designed to primarily emit UVA light (Figure 1). UVA light is generally considered the safest of the three UV ranges: UVA, UVB, and UVC. Although OSHA does not

currently regulate ultraviolet light exposure in the workplace, the American Conference of Governmental Industrial Hygienists (ACGIH) does recommend Threshold Limit Values (TLVs) for ultraviolet light. The strictest interpretation of the TLV (over the UVA range) for workers' eyes and skin is 1 mW/cm² (intensity), continuous exposure. Unless workers are placing bare hands into the curing area, it is unusual to exceed these limits. To put the 1 mW/cm² limit into perspective, cloudless summer days in Connecticut regularly exceed 3 mW/cm² of UVA light and also include the more dangerous UVB light (primarily responsible for sun tans, sun burns, and skin cancer) as well.

The human eye cannot detect "pure" UV light, only visible light. A radiometer should be used to measure stray UV light to confirm the safety of a UV light-curing process. A workstation that exposes an operator to more than 1 mW/cm² of UVA continuously should be redesigned.

UV light-curing of adhesives can be a regulatory compliant, "worker-friendly" manufacturing process when the proper safety equipment and operator training is utilized. There are two ways to protect operators from UV exposure: shield the operator and/or shield the source.

Shield the Operator

UV-Blocking Eye Protection - UV-blocking eye protection is recommended when operating UV light-curing systems. Both clear and tinted UV-blocking eye protection is available from Dymax.

UV-Blocking Skin Protection - Where the potential exists for UV exposure upon skin, opaque, UV-blocking clothing, gloves, and full-face shields are recommended.

Shield the Source of UV

Any substrate that blocks UV light can be used as a shield to protect workers from stray UV light. The following materials can be used to create simple shielding structures or blind corners:

Sheet Metal - Aluminum, steel, stainless steel, etc. Sheet metal should be coated black or black anodized to minimize reflection of UV and visible light toward operators.

Rigid Plastic Film - Transparent or translucent/UV-blocking plastics (typically polycarbonate or acrylic) are commonly used to create shielding where some level of transparency is also desired. These rigid plastic films are water-clear or tinted.

Flexible Film - UV-blocking, flexible urethane films can be used to quickly create workstation shielding. This UV-blocking, flexible urethane film is available from Dymax, call for assistance.

Figure 1.
UV Spectrum

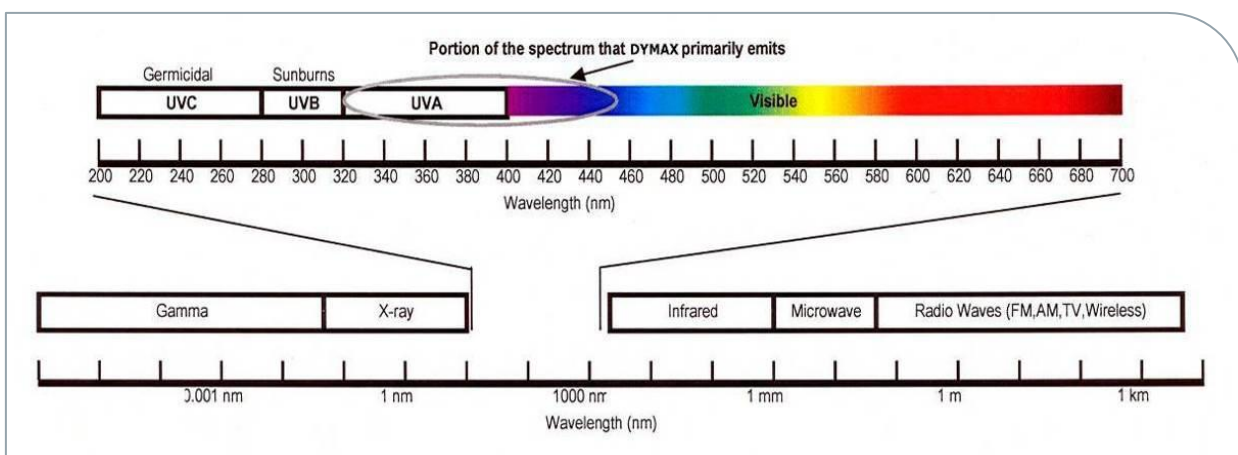

High-Temperature Surfaces

Surfaces exposed to high-intensity curing lights will rise in temperature. The intensity, distance, exposure time, cooling fans, and the type/color of the surface can all affect the actual surface temperature. In some cases, exposed surfaces can reach temperatures capable of producing a burn or causing damage to a substrate. In these cases, care must be taken to ensure a more moderate surface temperature or appropriate protection and training for operators.

Ozone

Standard Dymax bulbs (UVA type) generate an insignificant amount of UVC and therefore essentially no ozone. Some UV light-curing systems, like those used to cure UV inks, emit primarily “shortwave” (UVB and UVC) energy. Upon exposure to UVC light (specifically <240 nm), oxygen molecules (O₂) split into oxygen atoms (O) and recombine with O₂ to create ozone O₃. The current, long-term ozone concentration limit recommended by ACGIH, NIOSH, and OSHA is 0.1 ppm (0.2 mg/m³).

Bright, Visible Light

The bright, visible light emitted by some UV light-curing systems can be objectionable to some workers and can cause eyestrain. Tinted eye protection and/or opaque/tinted shielding can be utilized to address this concern.

Summary

UV light sources can be more “worker friendly” than many commonly accepted industrial processes, provided the potential concerns are addressed. Contact your Dymax representative for information regarding the proper use of Dymax UV light-curing systems.

Product Overview

The BlueWave 200 is a high-intensity, UV light-curing spot lamp system used for small-area curing of adhesives, coatings, and potting materials. It emits up to an 8-mm diameter spot of UV light from a liquid lightguide (sold separately). The lightguide can be hand-held for complete mobility or clamped into position on assembly equipment or workstations for repetitive operations.

The system consists of an anodized aluminum housing containing an electronic power supply, circuit protection, bulb/reflector assembly, internal light filter for extended

lightguide life, thermostatically controlled cooling fan, and LCD display. The shutter can be controlled through externally supplied signals in PLC Mode, with a foot pedal or button press in Manual Mode, or through a built-in timer triggered by a foot pedal or button press in Timer Mode.

The power supply operates on line voltages between 100 and 240 VAC, and frequency between 50 and 60 Hz. It is auto-ranging and is specially designed to provide proper rated voltage and current to the 200-Watt lamp.

A cooling fan with a control loop is provided to keep the lamp housing and internal components of the power supply at the optimum operating temperature. The cooling fan must not be covered or otherwise blocked. Ideal operation of this equipment suggests at least 12" (305 mm) of clearance behind the system for proper ventilation. Confirm that the intake fan is not feeding from the exhaust of other equipment.

The UV source is a 200-Watt, medium-pressure arc metal-halide bulb mounted in a reflector and focused to provide optimum light output. The BlueWave 200 is rated for continuous operation. The bulbs used to power all high-intensity UV light-curing spot lamps degrade with use. Intensity, therefore, decreases as the bulb ages. Using the system’s intensity control feature, users can eliminate this variation by manually increasing intensity to offset this degradation. During operation, a user can adjust the output intensity using a tool or removable knob. If the bulb extinguishes due to a momentary power failure, the BlueWave 200 must be turned off, allowed to cool, and then restarted to re-ignite the bulb. The LCD display will indicate when the bulb must be replaced.

A thermal shutdown sensor is provided for internal temperature control of the BlueWave 200. A cover switch and lightguide status switch increase the safety of the unit. If any of these sensors prevent the system from operating as intended, specific warnings appear on the LCD display.

When the BlueWave 200 is operating in PLC Mode, the LCD display shows the state of the signals which control the BlueWave 200 to help set up and verify correct operation of the system.

Unpacking the BlueWave 200

Unpacking and Inspecting Your Shipment

When your BlueWave 200 arrives, inspect the boxes for damage and notify the shipper of box damage immediately.

Open each box and check for equipment damage. If parts are damaged, notify the shipper and submit a claim for the damaged parts. Contact Dymax so that new parts can be shipped to you immediately.

Check that the parts included in your order match those listed below. If parts are missing, contact your local Dymax representative or Dymax Customer Support to resolve the problem.

NOTE: Lamps are shipped with the bulb/reflector installed.

Parts List

- BlueWave 200 Rev. 3.0 Spot Lamp (1)
- Power Cord (2)
 - 41015** – North American Version with 115V Power Cord
 - 41014** – Asian Version with Type G Plug
 - 41013** – No Power Cord (*NOTE: For European customers, the appropriate power cord is included*)
- Foot Pedal (3)
- Protective Goggles (4)
- Hex Key (5)
- Screwdriver (6)
- Intensity Adjustment Knob and Screw (7)
- BlueWave 200 User Guide (8)

Figure 2.
BlueWave 200 Rev 3.0 Components



Setting Up the BlueWave 200

To ensure proper operation and optimized performance, installation of the BlueWave 200 requires that it be placed on a horizontal, solid surface and located in an area of unrestricted airflow, such as an open counter. Over-heating of the unit can lead to accelerated bulb degradation or complete loss of performance of the bulb.

Note that the shutter is gravity operated and placing the unit on an angle or other than flat horizontally can affect shutter operation. Maintaining a 12" open space around the top, sides, and back of the unit ensures proper cooling, and in a location that is not affected by hot or cold draft airflow from other equipment or HVAC vents will insure an optimized operating environment. The unit has an intake fan and an output vent – locate the unit to assure heated air from the output vent is not recirculating into the air intake fan.

Figure 3.
Open Space Requirements

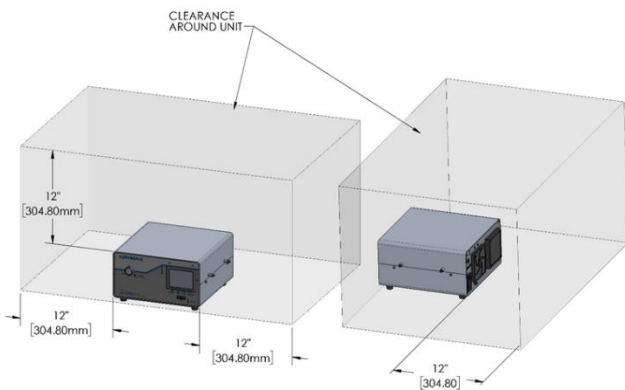

Providing adequate air clearance is not the only factor when positioning units; you must also ensure the hot exhaust of one BlueWave unit is not feeding into the intake of a nearby unit. Similarly, any other device that has hot exhaust could be influencing the intake air on the BlueWave. Units must have access to non-heated (room temperature) air and even if the space considerations are met, it cannot be an enclosed/sealed chamber. If units are to be located next to each other, they should be a minimum of 12 inches apart.

In addition, for the BlueWave 200 shutter system to work properly, the unit cannot be installed on its side or at an angle. Fan filters must be replaced when the lamp is replaced every 2,000 hours. In dirtier environments, the filters may need to be removed and cleaned weekly as an

interim to the 2,000-hour bulb replacement. If you need additional assistance in evaluating the environment or in setting-up your equipment, contact Dymax Applications Engineering.

1. Connect the Power Cord to the Power Receptacle on the rear of the BlueWave 200. Plug the Power Cord into a grounded wall outlet.
2. If you will be using a Foot Pedal, connect the Foot Pedal to the Foot Pedal Connection (Figure 4) on the rear of the BlueWave 200. A ground stud is also provided on the back of the BlueWave 200 if additional grounding is desired.
3. Remove the protective cover from the BlueWave 200's Lightguide Mount (Figure 5).

NOTE: Always have a Lightguide or the protective cap engaged in the Lightguide Mount. UV light can escape when the Shutter is activated.

Figure 4.
Cable Connections, BlueWave 200 Rev 3.0 Rear Panel



Figure 5.
Lightguide Mount, Protective Cover Removed



4. Remove the Protective End Caps from the Lightguide. Visually inspect the two ends of the Lightguide to verify that no foreign material is present. The ends of a Dymax liquid-filled Lightguide can be cleaned with isopropyl alcohol as required to remove foreign material and deposition from outgassing.

5. Insert the large end of the Lightguide into the Lightguide Mount until it snaps into place (Figure 6). A Lightguide Seated Indicator Icon will illuminate when the Lightguide is properly installed and the BlueWave 200 is turned on.

WARNING! Engage the Lightguide in the Bezel before the light is turned on and remove the Lightguide from the Bezel only after the light is turned off to avoid the possibility of exposure to the light. Lightly tighten the setscrew for safety.

Figure 6.
Insert Lightguide into Lightguide Mount



6. Fasten the Lightguide into place by lightly tightening the Setscrew located on the Lightguide Mount (Figure 7). A Hex Wrench is provided with the system for this purpose. The Setscrew should be tightened gently to prevent damage to the Lightguide.

Figure 7.
Gently Tighten Setscrew on Lightguide Mount with Hex Wrench



IMPORTANT: To ensure proper operation of the Shutter, be sure to completely insert the Lightguide into the Lightguide Mount prior to tightening the Setscrew. Be sure to lightly tighten the Setscrew to ensure the Lightguide remains in place during use.

NOTE: Multi-Leg Lightguides should be balanced by rotating the Lightguide to obtain the desired UV intensity of each leg before lightly tightening the Setscrew.

Becoming Familiar with the Controls

There are 4 simple controls which can adjust all features of the BlueWave 200 (Figure 8).

Figure 8.
Front Panel Controls

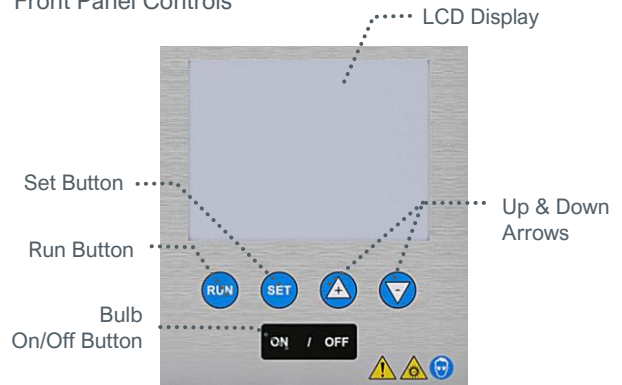

LCD Display – Displays operating mode, menus, settings, instructions and special messages.

Bulb On Button – Pressing this button turns the bulb on (except in PLC Mode).

Bulb Off Button — Pressing this button turns the bulb off. In PLC Mode, a press stops the *BlueWave 200* and puts it in safe state.

Run Button — Pressing this button will start a timed or manual curing cycle. In PLC Mode, it will open the shutter if the PLC has not inhibited the shutter.

Set Button — Pressing this button will change the unit's mode, enter menu selections, and/or enter a timer value depending on which menu is showing. A long press is necessary to change to PLC Mode.

Up and Down Arrow Buttons —These buttons are used to adjust timer and select menu items

Turning the BlueWave 200 On

1. Turn on the power by moving the On/Off Switch on the back panel to the on position (Figure 9).

Figure 9.
Back Panel On/Off Switch

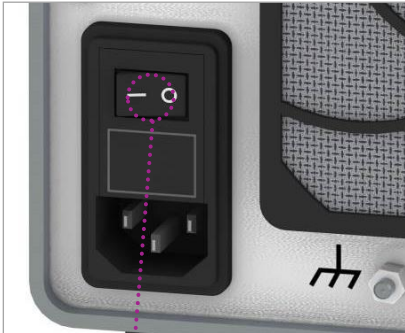

Press to turn on power

2. The LCD Display will turn on and show the product configuration screen (Figure 10).

NOTE: If you have already set the BlueWave 200 up for PLC operation according to the instructions in "Operating in PLC Mode" (Page 18), the bulb will be controlled by the PLC and the starting screens will be slightly different. See "Start-Up Screen for PLC Mode" (Page 18).

Figure 10.
Product Configuration Screen



3. Turn on the internal UV Bulb by pressing the On Button located on the front panel.

CAUTION! This is an arc, not a filament Bulb. Once ignited, it must be left on for a minimum of 10 minutes to vaporize elements in the Bulb. If not, the Bulb may be difficult to re-ignite. Each re-ignition increases the rate of Bulb degradation.

NOTE: You can turn off the Bulb at any time by pressing the Off Button on the front panel. The Bulb must be allowed to cool at least five minutes before it can be re-ignited. If the Bulb fails to ignite, an error message will appear on the LCD Display. Refer to "Troubleshooting" (Page 28).

Bulb life is reduced each time the system's bulb is turned on. Avoid repeated cycles that shorten bulb life by leaving the unit on through breaks.

If the amount that the Bulb has been on exceeds 2,000 hours, the BlueWave 200 will shut down and display a special screen prompting you to replace the Bulb. Refer to "Bulb Replacement Warning" (Page 25).

4. It can take up to 300 seconds (5 minutes) for the Bulb's temperature to stabilize. (Figure 11)

The BlueWave 200 continually checks the performance of the Bulb in addition to keeping track of its usage. If any problems are detected, the LCD will show special screens. Refer to "Solving Problems" (Page 28).

Figure 11.
Bulb Warm-Up Screen

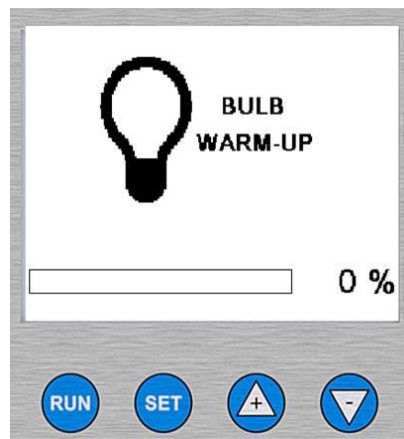

Setting an Operating Mode

Introduction to Operating Modes

Your BlueWave 200 has three basic operating modes: Manual Mode, Timer Mode, and PLC Mode.

Manual Mode: The shutter opens whenever the foot pedal or the run button on the front panel is pressed. When the shutter is open, UV light passes through the lightguide. The shutter remains open only as long as the foot pedal or run button is pressed. When the foot pedal and run button are released, the shutter closes, and no UV light passes through the lightguide.

Timer Mode: The shutter opens for a specific time period each time the foot pedal or run button is pressed. You must set the specific time by adjusting the timer's value on the screen. Momentarily pressing the foot pedal or run button starts the timer and opens the shutter. When the shutter is open, UV light passes through the lightguide. When the timer counts down to zero, the shutter closes, and the timer resets to the value that you set and is ready for another exposure cycle.

PLC Mode: An external PLC (Programmable Logic Controller) controls the unit. The PLC provides Input Signals to the BlueWave 200 to control the bulb and shutter. The PLC monitors the status of the unit by reading Output Signals provided by the BlueWave 200. The PLC is typically programmed to start other machinery when the BlueWave 200 becomes ready, or perhaps start the BlueWave 200 when other machinery is ready. The Input Signals and Output Signals are present through the 15-pin connector marked "Com Port" located on the back panel.

NOTE: A timed exposure can be interrupted with the Foot Pedal or the  Button on the front panel.

Choosing an Operating Mode

NOTE: Upon power-up, your BlueWave 200 will default to its last configuration settings.

Figure 12.

Mode Start-up Screens (Left to Right: Manual Mode, Timer Mode, PLC Mode)



Follow the instructions in "Turning BlueWave On" (Page 11). The BlueWave 200 will power up in Manual, Timer, or PLC Mode (Figure 12).

NOTE: If the BlueWave 200 powers up in PLC Mode, you cannot change modes from the front panel controls. Refer to the instructions on Page 15.

To Change from Manual Mode to Timer Mode:

1. From the Manual Mode Menu (Figure 12), press and release the **SET** Button.
2. Use the **▲** or **▼** Arrows to select "TIMER MODE". "TIMER MODE" will flash when it has been selected. (Figure 13)
3. Press and release the **SET** Button.
4. The BlueWave 200 will show the Adjust Timer Menu with the last used timer value (Figure 12). If the value on the timer is correct, then simply press the **SET** Button. If the value needs to be changed, press the **▼** or **▲** Arrows to correct the Timer's value. Press and release the **SET** Button after the correct value is on the display.

NOTE: Holding either key down changes the value quickly. Single presses of either key adjust the timer in 0.1 second steps.

5. The system is now in Timer Mode (Figure 15).

Figure 13.
Switching to Timer Mode

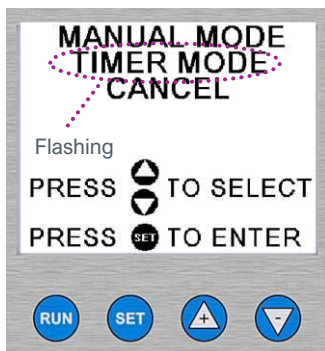

Figure 14.
Adjust Timer Mode



Figure 15.
Timer Mode Screen



To Change from Manual Mode to PLC Mode:



CAUTION! Always wear protective goggles or a face shield when working near UV light. Never look directly at the light exiting the lightguide. The PLC is capable of opening the shutter at any time, including when the bulb becomes ready in PLC mode or when a user selects PLC Mode from the front panel controls. Ensure the PLC is not commanding the Shutter to open when selecting PLC Mode.

1. Ensure that the PLC Dip Switch is set to "ENABLED". Refer to "Using the PLC Switch" (Page **Error! Bookmark not defined.**).
2. Press and hold the **SET** Button until the screen displays the PLC option. (Figure 16)

*NOTE: If you do not see "PLC MODE" on the screen, then you did not hold the button down for a long enough time. Use the **▼** and **▲** Arrows to select "CANCEL" and press the **SET** Button. No changes are made and you can try again.*

3. Use the **▲** and **▼** Arrows to select "PLC MODE". When selected, "PLC MODE" will flash.
4. Press and release the **SET** Button. The screen should look like Figure 17.

*NOTE: If the PLC Switch was not set correctly, the screen in Figure 18 will appear. Turn off the BlueWave and refer to "Using the PLC Switch" (Page **Error! Bookmark not defined.**) for instructions on how to set the PLC Dip Switch.*

Figure 16.
Entering PLC Mode



Figure 17.
PLC Mode

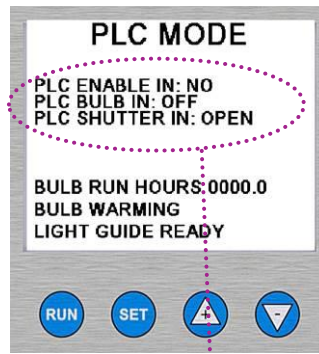

Messages may vary depending on PLC input signals

Figure 18.
Message to Set PLC Switch



To Change from Timer Mode to Manual Mode:





1. From the Timer Mode Menu (Figure 19), press and release the  Button.
2. Use the  and  buttons to select “MANUAL MODE”. “MANUAL MODE” will flash when selected. (Figure 20)
3. Press and release the  Button.
4. The system is now in Manual Mode and has the screen shown in the Figure 21.

Figure 19.
Timer Mode Menu



Figure 20.
Switching to Manual Mode

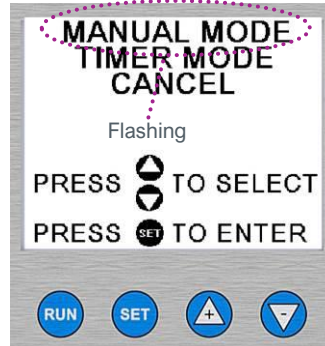
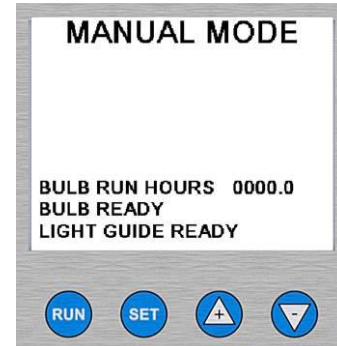

Figure 21.
Manual Mode Screen



To Change from Timer Mode to PLC Mode:





CAUTION! Always wear UV-blocking protective goggles or a face shield when working near UV light. Never look directly at the light exiting the lightguide. The PLC is capable of opening the shutter at any time, including when the bulb becomes ready in PLC mode or when a user selects PLC Mode from the front panel controls.

1. Ensure that the PLC Dip Switch is set to “ENABLED”. Refer to “Using the PLC Switch” (Page **Error! Bookmark not defined.**).



2. Press and hold the  Button until the screen changes to Figure 22.

NOTE: If you do not see “PLC MODE” on the screen, then you did not hold the button down for a long time. Use the  and  Arrows to select “CANCEL” and press the  Button. No changes are made and you can try again.



- Use the  and  Arrows to select “PLC MODE”. It will flash when selected.
- Press and release the  Button. The screen should look like Figure 23.

Figure 22.
Entering PLC Mode



Figure 23.
PLC Mode

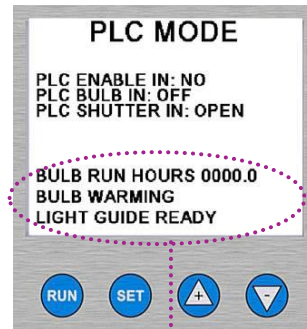

Messages may vary depending on PLC input signals

Figure 24.
Message to Set PLC Switch



NOTE: If the PLC Switch was not set correctly you will see the screen in Figure 24. Turn off the system and refer to “Using the PLC Switch” (Page 18) for instructions on how to set the PLC Dip Switch.

To Change from PLC Mode to Manual Mode or Timer Mode:

NOTE: You cannot exit PLC Mode by pressing any keys on the front panel. You must follow the procedure below.

- Refer to “Using the PLC Switch” (Page **Error! Bookmark not defined.**).
- Set the switch to “PLC MODE DISABLED”.
- Re-attach the covers and screws.
- Plug the AC Cord into a source of power.
- Turn the BlueWave 200 on using the On/Off Switch on the back panel.
- Press the On Button on the unit’s front panel.
- After the Bulb warm-up sequence is complete, the BlueWave 200 will return to Timer Mode or Manual Mode, depending on how it was used before entering PLC Mode.

Operating in Manual Mode

Manual Mode Description

Manual Mode means that the shutter opens whenever the foot pedal or the run button on the front panel is pressed. When the shutter is open, UV light passes through the lightguide. The shutter remains open only as long as the foot pedal or run button is pressed. When the foot pedal and run button are released, the shutter closes and no UV light passes through the lightguide.

We recommend you follow the instructions in “Setting the Intensity” (Page 25).

Procedure



CAUTION! Always wear protective goggles or a face shield when working near UV light. Never look directly at the light exiting the lightguide.

1. Ensure the BlueWave 200 is in Manual Mode (Figure 25).

NOTE: If the BlueWave 200 is not in Manual Mode, follow the instructions in “Choosing an Operating Mode” (Page 12).

2. Position the Lightguide end no closer than 0.25" [0.64 cm] from the material being cured. Positioning the Lightguide End too close can cause the Lightguide End to become cloudy from vapors coming off the curing material. This cloudiness can reduce UV output by as much as 50%.

3. Press and hold the Foot Pedal or the  Button on the front panel to open the Shutter.

NOTE: If the Lightguide is not inserted, the Shutter will not open. The LCD Screen will display a temporary message to insert the Lightguide (Figure 26).

4. To stop exposure, release the Foot Pedal or the  Button on the front panel.

Figure 25.
Manual Mode Screen



Figure 26.
Lightguide Error Screen



Operating in Timer Mode

Timer Mode Description

Timer Mode means that the shutter opens for a specific time period each time the foot pedal or run button is pressed. You must set the specific time by adjusting the timer's value on the screen. Pressing the foot pedal or run button starts the timer and opens the shutter. When the shutter is open, UV light passes through the lightguide. When the timer counts down to zero, the shutter closes. Once the exposure cycle is completed, the timer is automatically reset to the value that you set. The BlueWave 200 is immediately ready to accept another foot pedal or run button press to open the shutter.

NOTE: A timed exposure can be interrupted with the Foot Pedal or the  Button on the front panel.

We recommend you follow the instructions in "Setting the Intensity" (Page 25) periodically.







Procedure to Adjust Timer



CAUTION! Always wear protective goggles or a face shield when working near UV light. Never look directly at the light exiting the lightguide.

1. Ensure the BlueWave 200 is in Timer Mode. (Figure 27)

NOTE: If the BlueWave 200 is not in Timer Mode, follow the instructions in "Choosing an Operating Mode" (Page 12).

2. If the time on the screen is correct, skip to Step 8. Otherwise, you need to adjust the Timer to the correct value by following the next step.
3. Press and release the  Button.
4. Use  or  Arrows so that "ADJUST TIMER" is flashing. (Figure 28)
5. Press and release the  Button.
6. Press the  or  Arrows to adjust the Timer value to the correct value. (Figure 29)

NOTE: Holding either key down changes the value quickly. Single presses of either key adjust the timer in 0.1 second steps.

Figure 27.
Timer Mode Screen



Figure 28.
Adjust Timer Menu Selection



Figure 29.
Adjusting the Time



7. After the correct value is showing on the screen, press the  Button.
8. Position the Lightguide End no closer than 0.25" [0.64 cm] from the material being cured. Positioning the Lightguide End too close can cause the Lightguide End to become cloudy from vapors coming off the curing material. This cloudiness can reduce UV output by as much as 50%.

9. Press the Foot Pedal or the  Button on the front panel to start the Timer.

NOTE: An exposure cycle can be cancelled at any time by momentarily pressing the  Button or Foot Pedal.

If the Lightguide is not inserted, the Shutter will not open. The LCD Screen will display a temporary message to insert the Lightguide as shown below.

10. The Shutter opens and the Timer starts counting down to zero.

NOTE: When the Timer reaches 0, the Shutter closes automatically, and the Timer is reloaded with the value that was last used. The BlueWave 200 is immediately ready to accept another press of the Foot Pedal or the .

Figure 30.
Lightguide Error Screen



Operating in PLC Mode

PLC Mode Description



CAUTION! Always wear protective goggles or a face shield when working near UV light. Never look directly at the light exiting the lightguide. The PLC is capable of opening the shutter at any time, including when the bulb becomes ready in PLC mode or when a user selects PLC Mode from the front panel controls.

PLC Mode means that an external PLC (Programmable Logic Controller) controls the system. The PLC provides Input Signals to the BlueWave 200 to control the bulb and shutter. The PLC monitors the status of the unit by reading Output Signals provided by the BlueWave 200. The PLC is typically programmed to start other machinery when the BlueWave 200 becomes ready, or perhaps start the BlueWave 200 when other machinery is ready. The Input Signals and Output Signals are present on a special connector on the back of the BlueWave 200.

NOTE: Output Signals are always provided in Manual Mode and Timer Mode to allow simple interfacing to alarms, counters, other interlocks, etc. even if a PLC will not be controlling the BlueWave 200. However, the input signals will be ignored in Manual Mode and Timer Mode.

Start-Up Screen for PLC Mode

In PLC Mode, the BlueWave 200 displays a special start-up screen while it conducts internal diagnostics for a few seconds. As soon as unit finishes its tests, it can be immediately controlled by the PLC. The BlueWave 200 will always return to PLC Mode after power is turned off and on, or after power outages, until a specific procedure is followed to exit PLC Mode.

Figure 31.
Start-Up Screen for PLC Mode



Using the PLC Switch

The PLC Switch must be used to enter and exit PLC Mode so that accidental key presses on the front panel will not interfere with automated operations controlled by a PLC. To access the PLC Switch, the Outer Cover must be removed. Then the Inner Cover must be removed. After the Switch is located and set to the intended position, both the Inner and Outer Covers must be replaced.



CAUTION: Always unplug the unit before opening the Cover.

Locating the PLC Switch

1. Loosen the four Screws on the Outer Cover and remove it. (Figure 32)
2. Remove the four Screws on the Inner Cover and remove it. (Figure 32)
3. Locate the PLC Switch (Figure 33).

Figure 32.
Removal of the Covers

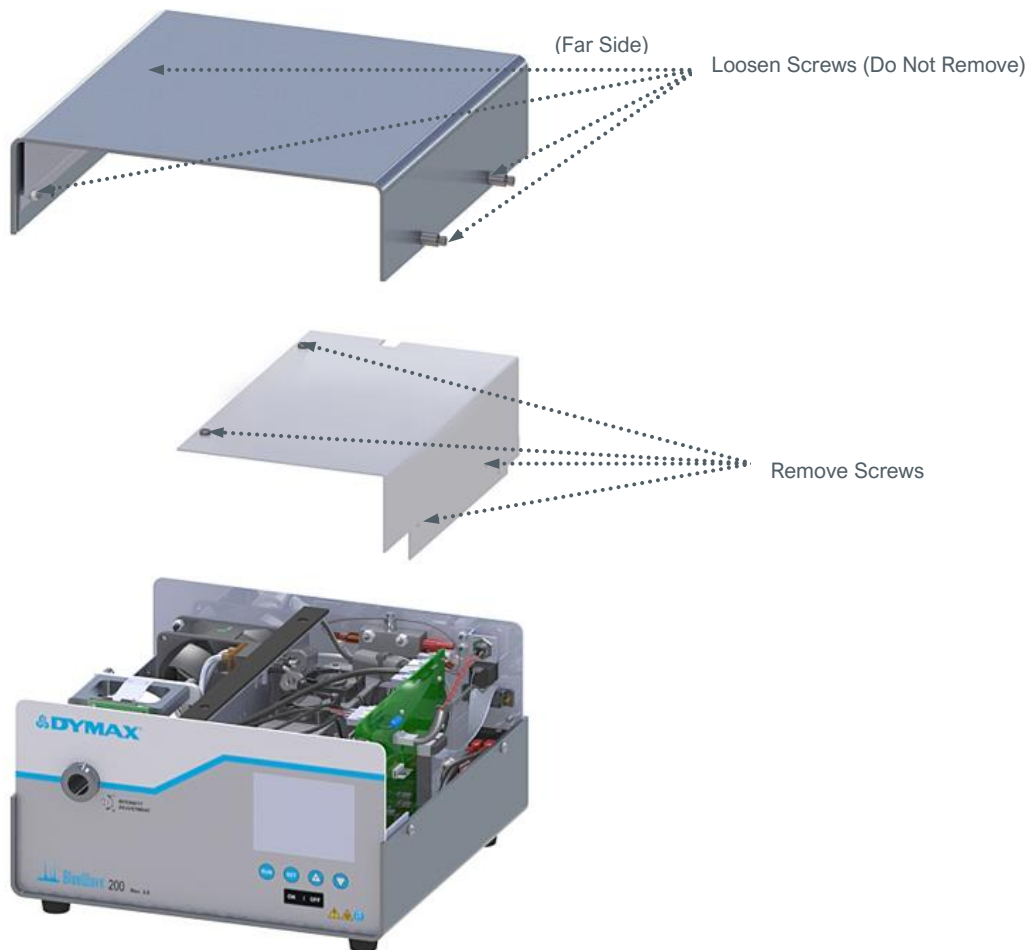
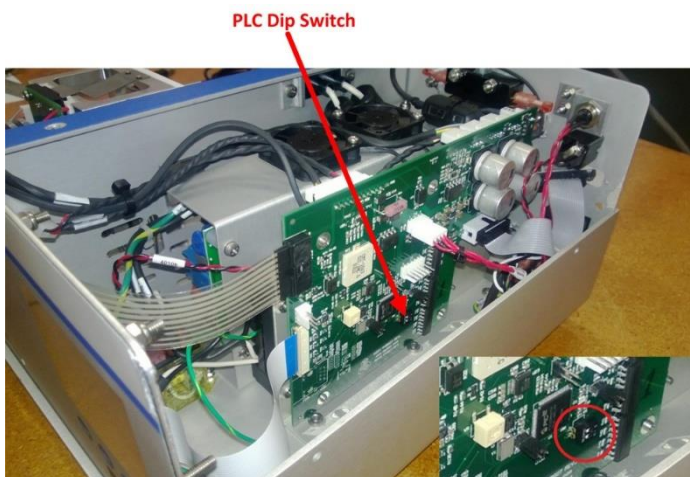

Figure 33.
PLC Dip Switch Location



4. Adjust the PLC Switch (see below) and replace the Inner and Outer Covers.

Adjusting the PLC Switch

When Switch 2 is moved towards the back panel, PLC Mode is enabled. PLC Mode can be activated from front panel key presses. When Switch 2 is moved towards the front panel, PLC Mode is disabled. (Figure 34)

Figure 34.
Dip Switch Setting

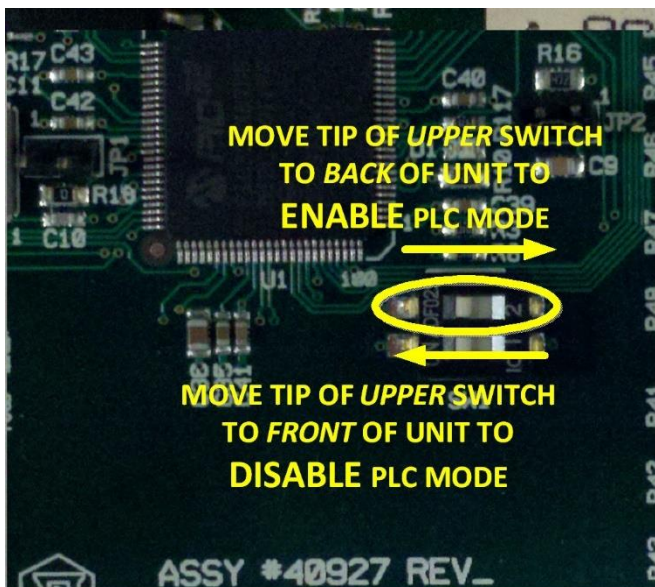

Wiring the PLC Interface

The following information will allow you to connect any PLC to the BlueWave 200.

Input Signal Definition

NOTE: Asserting an input signal means connecting the input pin to +24VDC return. Approximately 12 mA will flow out of the pin. The current is provided from the +24 VDC supply. A sample wiring diagram is given in Figure 35 (Page 23). Un-asserting an input signal means removing the connection to +24VDC such that less than 1 μ A of current is drawn from the pin.

All input signals are ignored until the BlueWave 200 is placed in PLC Mode.

Table 1.
Input Signals to the BlueWave 200

Signal Name	Pin Number	Definition and Notes
+24 VDC Input	1	This is a power input to the BlueWave 200 and acts as a supply for input signals. The supply should be regulated to 24 VDC +/- 10% and free of noise.
+24 VDC Return	2	This is the return to the power supply, and also the return for all output signals. a.k.a. negative, common, ground
Remote Shutter Activate	3	When asserted, this signal will cause the shutter to open if: <ol style="list-style-type: none"> 1) The lightguide is fully inserted 2) The bulb is Ready 3) The BlueWave 200 is operating without faults 4) The remote shutter inhibit signal is not asserted 5) The PLC remote enable signal is asserted 6) The BlueWave 200 is in PLC Mode 7) The BlueWave 200 has power and the switch on the back is turned on.
Remote Shutter Inhibit	4	When asserted, this signal will prevent the shutter from opening if: <ol style="list-style-type: none"> 1) The PLC remote enable signal is asserted 2) The BlueWave 200 is in PLC mode
Remote UV Lamp Control	5	When asserted and the following conditions are met, the bulb will turn on and begin its warm-up cycle if: <ol style="list-style-type: none"> 1) The BlueWave 200 is operating without faults 2) The PLC remote enable signal is asserted 3) The BlueWave 200 is in PLC mode
Remote PLC Enable	6	When un-asserted, all other input signals are ignored and treated as un-asserted. <i>NOTE: The LCD display will always show the actual state of all input signals whether remote PLC enable is asserted or un-asserted.</i>

Output Signal Definition

NOTE: Output signals which are asserted can sink up to 2.5 mA with 5 VDC maximum between signal output pin and +24 VDC return. The current flows out of the +24 VDC return pin. A sample wiring diagram is given in Figure 35 (Page 23). Each Output signal which is not asserted may draw up to 5 μ A of current.

Table 2.
Output Signals from the BlueWave 200

Signal Name	Pin Number	Definition and Notes
Unit Ready	7	When asserted, this signal means: 1) The BlueWave 200 is operating without faults 2) The bulb is ready <i>NOTE: It does not necessarily indicate that the shutter on the unit can be opened. Use the two signals Unit Ready and Lightguide Status to determine when the shutter is ready to be opened.</i>
UV Bulb Lit	8	When asserted, this signal means the unit is attempting to ignite the bulb, or the bulb is warming up, or the bulb is ready for use.
Shutter Fault Detected	9	When asserted, this signal means a fault has been detected with the shutter mechanism, and the BlueWave 200 cannot operate normally.
Temperature Fault Detected	10	When asserted, this signal means the unit is too hot or too cold, or cannot read its temperature sensor. The BlueWave 200 cannot operate normally.
1,950 Hour Warning	11	When asserted the bulb has been operating for 1,950 hours or more, and a replacement will be needed soon. The BlueWave 200 can operate normally in this condition but will shut itself off when the bulb has 2,000 hours of operation. <i>NOTE: Use this signal to display a maintenance warning so the bulb can be replaced at a convenient time without interrupting production.</i>
2,000 Hour Shut Off	12	When asserted, the bulb has been operating for more than 2,000 hours, and the bulb has been turned-off by the BlueWave 200. The BlueWave 200 cannot continue to operate normally. <i>NOTE: Unit ready will become un-asserted when 2,000 hour shut off is asserted.</i>
Unit Power	13	When asserted, this signal means: 1) The switch on the back panel is in the on position, and 2) The unit is plugged into an AC power source
Lightguide Status	14	When asserted, the lightguide is seated within the lightguide housing.
Shutter Open	15	When asserted, the shutter is open.

Sample Wiring Diagram

Figure 35.
Sample Wiring Diagram

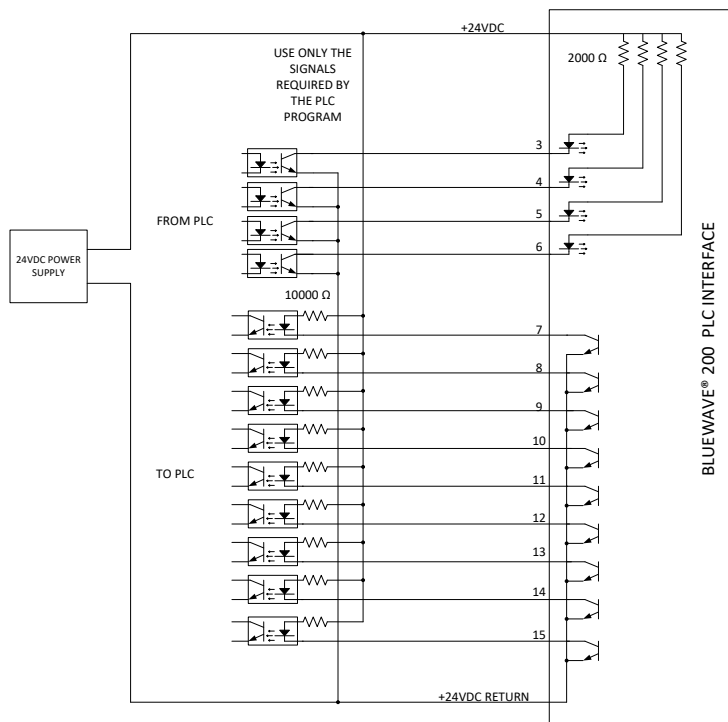

Connector Pin Out

The PLC Connector pin numbers are shown in Figure 36 below.

Figure 36.
Connector Pin Out

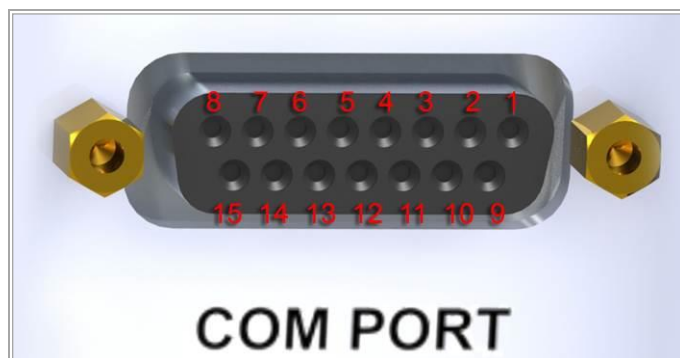

PLC Front Panel Emergency Stop

Press the Off Button on the Front Panel to close the Shutter and turn off the Bulb to immediately override any commands issued by the PLC. The switch on the back panel must be turned off and on before the BlueWave 200 can re-enter PLC Mode.

Figure 37.
PLC Emergency Stop Function

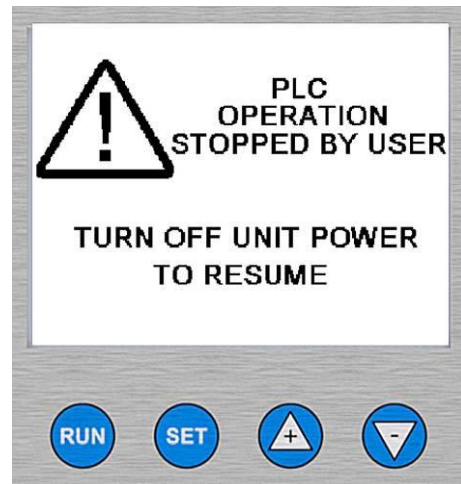

Troubleshooting the PLC Interface

Monitoring Input Signals

The LCD Screen gives the status of all of the input signals when the unit is in PLC Mode. (Figure 17, pg. 14). You use this information to troubleshoot PLC operation, programming, and wiring. (Table 2)

Table 2.
LCD Indications and Input Signal States

Signal	Text On LCD Screen	Signal State
Remote PLC Enable	PLC Enable In: Yes	Asserted
	PLC Enable In: No	Un-Asserted
Remote UV Lamp Control	PLC Bulb In: Yes	Asserted
	PLC Bulb In: No	Un-Asserted
Remote Shutter Activate and Remote Shutter Inhibit	PLC Shutter In: Closed	Remote Shutter Inhibit is Un-Asserted Remote Shutter Activate is Un-Asserted
	PLC Shutter In: Open	Remote Shutter Inhibit is Un-Asserted Remote Shutter Activate is Asserted
	PLC Shutter In: Inhibit	Remote Shutter Inhibit is Asserted

Testing the Shutter

When the unit is in PLC mode, as long as Remote Shutter Inhibit is not asserted, pressing the  Button or closing the Foot Pedal will open the Shutter so that optical fixturing can be set up or verified.

Setting the Intensity

The bulbs used to power all high-intensity UV light-curing spot lamps degrade with use. Intensity, therefore, decreases as the bulb ages. Using the BlueWave 200's patented intensity adjustment feature, users can eliminate this variation by manually increasing output intensity to offset this degradation.

The intensity can be adjusted with a flat-head screwdriver or the removable Intensity Adjustment Knob (Figure 38). The Intensity Adjustment Feature is useful for both validation and control.

1. Set the BlueWave 200 to operate in Manual Mode. Refer to "Choosing an Operating Mode" (Page 12).
2. Use the Foot Pedal to open the Shutter.
3. With the Shutter open, adjust the Intensity Adjustment Screw as required to achieve the desired output intensity.

Figure 38.
Adjust Intensity with a Tool or the Removable Knob



Setting Up the Curing Process

Methods

Prior to production, Dymax advises customers to conduct testing to determine the time and intensity required to fully cure their resin in their specific application. Typically, users validate by one of the following methods:

- **Set Exposure Time, Determine Intensity** - Users can specify a cure time and through empirical testing, determine the intensity required to achieve full cure. As with any manufacturing process, it is advisable to incorporate a safety factor.
- **Set Intensity, Determine Exposure Time** - Users can specify intensity and through empirical testing, determine the exposure time required to achieve full cure. As with any manufacturing process, it is advisable to incorporate a safety factor.

Maintaining Process Control

BlueWave 200 Bulbs will typically vary less than 1% over eight hours of normal use, and daily or weekly adjustments are adequate to maintain a tightly controlled process. For your convenience, the BlueWave 200 reports the number of hours the Bulb has been operating on the LCD Display.

A Bulb Change Message and a Lamp Icon will appear on the LCD display to alert the operator to check Bulb operation or to change the Bulb if required.

Maintaining the BlueWave 200

The BlueWave 200 was designed to operate with minimum maintenance. Typically, the Bulb must be replaced after it has operated for 2,000 hours.

Bulb Replacement Warning

As the Bulb nears the end of its 2,000-hour life, the LCD Display will begin flashing the Bulb Hours. The 1,950 Hour Warning output on the PLC connector also becomes asserted.

Bulb Replacement Procedure

1. Bulb replacement is easily accomplished by following the steps below. Refer to the labeled diagrams under the light source cover.
2. Ensure that the Power Cord is unplugged from the rear of the BlueWave 200.
3. Remove the top cover from the system by loosening the four Cover Fasteners (Figure 39).

Figure 39.
Remove Cover

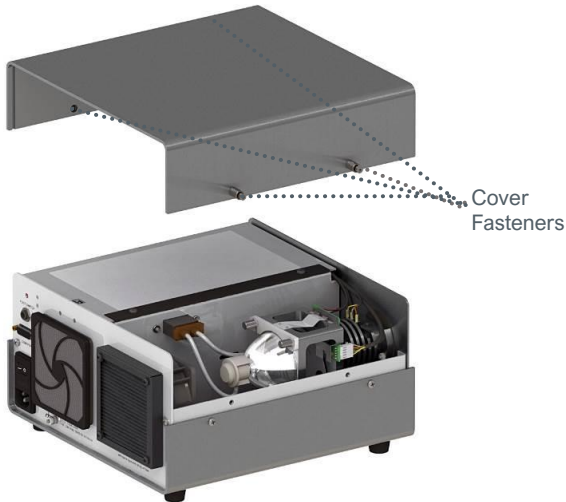

4. Unplug the Bulb and Lift the Bulb Mounting Bracket (Figure 40) from it. Remove the Bulb from the Bulb Mount.

Figure 40.
Lift Bulb Mounting Bracket and Remove Bulb

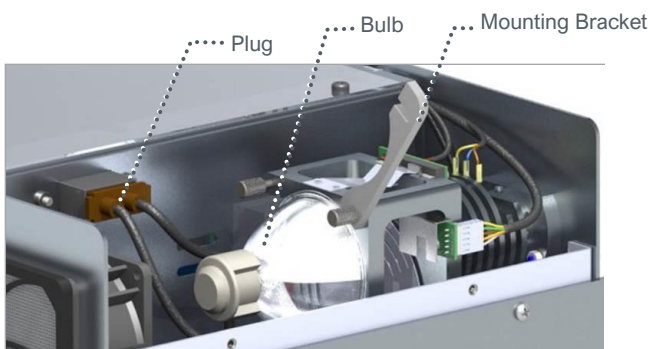

Unpack the new Bulb. Take care not to bend the flat Electrode in the center of the Bulb (Figure 41).

Install the new Bulb, plug the Bulb in and tighten the two Mounting Bracket Thumbscrews (Figure 42). Make sure that the center Electrode connecting the Bulb to the wire from the Reflector is parallel to the bottom of the system. Re-install the BlueWave 200's cover.

Figure 41.
Bulb

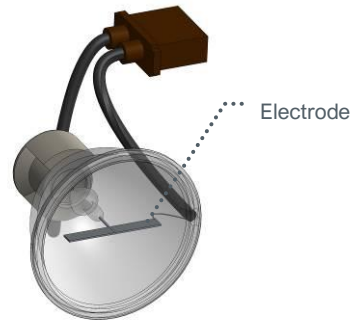
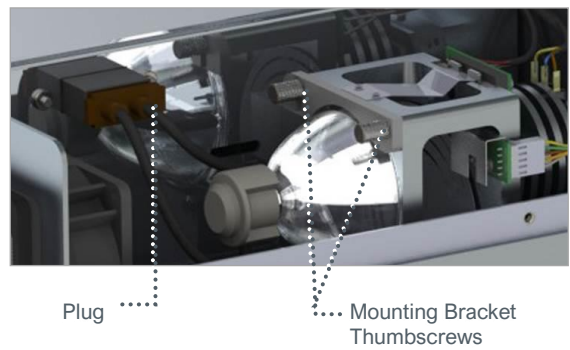

Figure 42.
Installed Bulb



5. Plug in and turn on the BlueWave 200. Press and release the red Reset Button on the back of the BlueWave 200 (Figure 43). This completes Bulb installation. When the BlueWave 200 is turned on, the Bulb will now ignite and is now reset to operate for 2,000 hours.

NOTE: If the Bulb does not light, repeat instruction 5-7 to verify all steps were done correctly.

Figure 43.
Reset Button, Rear Panel

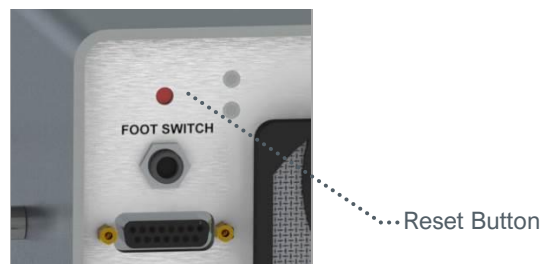

Lightguide

Clean the ends of the lightguide monthly or as required. The ends of the lightguide should be kept clean to transmit as much light as possible. Cured adhesive can be removed from a liquid lightguide with a razor blade. Avoid sharp bends with the lightguide since this reduces light output and damages the guide.

Fan Filter

The external Fan Filter should be inspected and cleaned periodically to prevent dust buildup from affecting airflow through the BlueWave 200. Spare Fan Filters are provided with each BlueWave 200 and with replacement Bulbs. It is recommended to install the new fan filter when installing the new replacement bulb. The Fan Filters are washable and may be reused. Remove the Fan Filter by removing the snap-on cover from the rear of each grill (Figure 44).

Figure 44.
Intake Fan with Fan Filter Removed



System Cleaning

The unit's outer surfaces and front panel can be cleaned using isopropyl alcohol or a mild detergent cleaning agent. Do not use an abrasive cleaner as it will damage the unit surfaces.

Fuse Replacement

The BlueWave 200 has two Fuses that are installed in the Power Receptacle. To remove the Fuses, unplug the BlueWave 200 and remove the Fuse Holder with a small screwdriver. Remove the Fuses from the Fuse Holder and install new Fuses. Replace the Fuse Holder into the Power Receptacle. The correct Fuses are Dymax PN 41099, 4.0 Amp fast-acting type.

Figure 45.
Power Receptacle



Figure 46.
Fuse Holder



Figure 47.
Fuses Removed from Holder



Solving Problems

Troubleshooting

WARNING! Only qualified maintenance personnel should attempt the following procedures:

Table 3.
Troubleshooting Chart for BlueWave 200

Problem	Possible Cause	Testing	Corrective Action
Bulb Will Not Ignite	Improper connections	Visually inspect all input/output connections and Fuses (i.e. Power Cord, Bulb).	Secure all connections.
	Bulb beyond useful life of 2,000 hours	Replace the old Bulb with a new Bulb/Reflector Assembly. Reset the Bulb Hour Meter and re-test.	Replace the Bulb/Reflector Assembly if required (typical life = 2,000 hours).
	Main line Fuse blown (nothing in BlueWave 200 operates)	Remove the Fuse from the Power Receptacle and check it with an Ohmmeter.	Replace the Fuse if defective.
Low Output Intensity or Fails to Cure Adhesive in Allotted Time	Bulb beyond useful life	Use a Radiometer (ACCU-CAL™ 50 or equivalent) to measure output intensity.	Replace the Bulb/Reflector assembly if beyond useful life (typical = 2,000 hours).
	Transmission loss in Lightguide too great	Compare the lightguide output against a new lightguide (or use the Dymax lightguide simulator) to determine transmission loss.	Replace the Lightguide.
	Contaminants on Lightguide	Visually examine ends of Lightguide for contaminants.	Clean with Lightguide Ends with isopropyl alcohol (or equivalent). Heavy deposits on liquid Lightguides may be removed with a razor blade. Replace the Lightguide if it cannot be cleaned.
	The Bulb/Reflector Assembly is not installed properly	Visually check to make sure the Bulb/Reflector Assembly is seated flush in the Bulb Mount Assembly (any error in installation could cause low output).	Properly install the Bulb/Reflector Assembly.

Frequently Asked Questions

Q. My BlueWave 200 will not turn on.

- Check the Power Cord connection.
- Check the Fuses located where the Power Cord plugs into the BlueWave 200.

Q. The Bulb will not ignite; it only “flickers”.

- Replace the Bulb. Excessive power cycling will shorten the life expectancy of the Bulb. This is an arc, not a filament Bulb. Once ignited, it must be left on for a minimum of 10 minutes to fully vaporize elements in the Bulb. If not, the Bulb may be difficult to re-ignite. Each re-ignition increases the rate of Bulb degradation.

Q. I installed a new Bulb, and it still will not ignite.

- Check to make sure the Bulb Connector is fully seated into the Igniter.
- The BlueWave® 200 has a safety shutdown feature at 2,000 hours. If the equipment has reached the safety shutdown point, the hour meter on the front of the unit will alternate between "CHANGE BULB" and "2000.0", and the bulb will not light. When this happens, the *BlueWave 200* will no longer supply an ignition voltage to the bulb until the reset switch is pressed on the back of the equipment. The power must be on for this reset to be performed. The reset switch should always be pressed whenever a new bulb is installed, and a bulb should never be operated after it reaches the 2000-hour life expectancy.

Q. Why do I have low intensity, even with a new Bulb?

- The Lightguide may not be fully seated into the Lightguide Mount.
- The intensity is being checked too early. The 200-Watt Bulb will not reach full intensity until 10 minutes after initial power up.
- The end of the Lightguide may have a build-up of adhesive and the collecting of out-gassing. Large deposits of debris should be removed using the flat edge of a razor blade to scrape the deposit away. Take care as to not scratch the glass. Always clean the ends with Isopropyl Alcohol. Chlorine based solutions can also be exceptionally damaging to liquid lightguides and should not be used for cleaning.
- The condition of the Lightguide will also affect the intensity. All Lightguides degrade with time, but intensity will also drop if the Lightguide is bent, compressed, or leaking. Look for chips and cracks in

the Lightguide ends. Confirm there are not any kinks or severe bends in the length of the Lightguide. A leaking Lightguide will drastically reduce intensity transfer. Lightguides should be seated properly within the Lightguide mount and never be bent more than their natural bend radius. The intensity reading from the Lightguide should be compared to the intensity reading from a Lightguide Simulator to determine the efficiency. Take a reading of the new bulb using a Lightguide simulator (PN 38408). Remove the simulator and install the Lightguide used during production. The difference between the two readings should supply a good assessment into the performance of the Lightguide. Unacceptable intensity loss should result in cleaning or the replacement of the Lightguide.

- The standard BlueWave 200 has a Filter Lens installed, which filters the light before it reaches the Light Guide. The light intensity will be decreased as the light that passes through the filter is restricted by dust and debris. Debris can accumulate on the filter lens if the Lightguide cover or Lightguide is removed for any length of time. The filter lens can be found inside the spot equipment. With the unit powered off, remove the Lightguide from the front of the equipment. From this point an observer can look into the Lightguide mount (the hole where the Lightguide is inserted) and view the filter lens. It will appear purple, green, and blue in color. By using a can of air, the filter lens can be gently cleared of any dust or debris that can be seen.
- Incorrect installation of the Bulb. Bulb orientation is vital during the installation of the Bulb. Refer to the Bulb installation instructions supplied with all new 200-Watt Bulbs for the proper installation procedure.

Q. My Foot Pedal is not operating.

- Check the connection of the Foot Pedal into the BlueWave 200.
- Inspect the foot switch cord for any signs of wear or damage. Replace as needed.

Q. What causes my Shutter to hesitate to open when I activate my Foot Pedal?

- Maintaining clean equipment and a clean working environment will help prevent the buildup of dust and other debris from collecting on the mechanical parts of the *BlueWave 200*. Debris that settles in the piston well (adjustment screw) can hinder the movement of the Shutter Solenoid Piston.
- Shutter alignment to Reflector Mount incorrect.
- The Shutter is a mechanical part which may wear after extended use.

- Incorrect alignment of the Shutter to the Bulb Mount Assembly.

If the problem still exists please contact Dymax Customer Support

Q. Why does my shutter sometimes hesitate to close?

- This problem may also relate to the cleanliness of the working environment. Dust and debris can collect and cause the Shutter to work improperly.
- Shutter alignment to Reflector Mount incorrect.
- The Shutter is a mechanical part which may wear after extended use.
- Incorrect alignment of the Shutter to the Bulb Mount Assembly.

If the problem still exists please contact Dymax Customer Support

Q. Why does my BlueWave 200 seem to run very hot?

- Ideal operation of this equipment suggests at least 12" of clearance behind the *BlueWave 200* for proper ventilation.—Confirm there is enough clearance for the intake and exhausts fans behind the equipment to provide adequate cooling to the unit, less than the suggested clearance could potentially allow the intake fan to feed from the exhaust fan which may cause overheating. Confirm that the intake fan is not feeding from the exhaust of other equipment.
- Replace the Fan Filter Media on the Intake and Exhaust vents located in the back of the equipment. This is your first line of defense against airborne dust and debris. This filter media is supplied with new bulbs and should be changed regularly.
- Equipment may already be full of dust and debris causing overheating/damage to the bulb and internal electronics.

If the problem still exists please contact Dymax Customer Support

Diagnostic Display

The LCD Screen will display any faults detected by the BlueWave 200 (Figure 48). Contact Dymax for assistance, since most faults can be resolved over the phone.

Figure 48.
Diagnostic LCD Screen

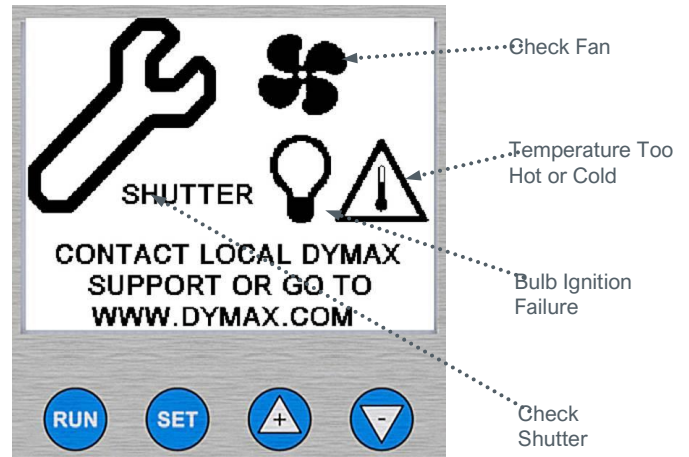

Spare Parts and Accessories

Spare/Replacement Parts

Item	Part Number
Bulb/Reflector	
Bulb/Reflector Assembly	38465
Clip, Reflector Upper (Teflon)	38548
Clip, Spring, Lower	39609
Fan	
Fan 24 VDC	41028
Fan Filter Holder and Media	38587
Misc. System Components	
Foot Pedal	40402
Fuses: 4A	41099
Feet (Rubber Bumper)	38572
Filter, Bandpass	35986

Options/Accessories

Item	Part Number
Lightguides	
Lightguide Simulator	38408
Liquid-D Lightguide, 5 mm x 1 Meter	5720
Liquid-D Lightguide, 5 mm x 1.5 Meter	5721
Liquid-D Lightguide, 8 mm x 1 Meter	5722
Liquid-D 2-Pole Lightguide, 3 mm x 1 Meter	38476
Liquid-D 3-Pole Lightguide, 3 mm x 1 Meter	38477
Liquid-D 4-Pole Lightguide, 3 mm x 1 Meter	38478
Fiber Optic 2-Pole Lightguide, 3 mm x 1 Meter	39783
Fiber Optic 3-Pole Lightguide, 3 mm x 1 Meter	39787
Fiber Optic 4-Pole Lightguide, 3 mm x 1 Meter	39791
5 mm Lightguide End Protector (12% Energy Loss)	40539
Miscellaneous	
ACCU-CAL™ 50 Radiometer (Spot Model)	39560
BlueWave Case with Foam	38679

Specifications

Property	Specification
Part Numbers	41015 North American Version (with 115V standard plug) 41014 Asian Version (with type G plug) 41013 BlueWave 200 with no power cord*
Intensities	Total (280-450) 40+ W/cm ² Visible (400-450 nm) 17+ W/cm ² UVA** (320-395 nm) 17+ W/cm ² UVB (280-320 nm) 7 W/cm ²
Power Requirements	100 to 240 VAC, 50 to 60 Hz, 2.5 Amps
Power Supply	Solid State, 200 Watt
Bulb	200-Watt mercury bulb included; replacement in less than a minute
Reflector	Elliptical; glass with dichroic coating to reflect UV and minimize IR
Shutter Timer	0-9999 seconds, 0.1 seconds resolution
Shutter Activation	Foot Pedal, Front Panel Key Press, or PLC
I/O Port	15-Pin D – sub-miniature connector
Signals (PLC Integration)	Inputs Shutter activate, shutter deactivate, lamp control, PLC enable Outputs Unit status, temperature fault, shutter fault, lamp status, power status, shutter status, lightguide status, bulb life warning, bulb life expired
Cooling	Filtered, single fan arrangement; thermally controlled to maintain proper lamp temperature
Operating Conditions	0 – 40°C, 0-80% relative humidity, non-condensing
Display	LCD, monochromatic, 320 by 240 pixels
Housing Dimensions	12.5" x 12.0" x 6.5" (31.8 cm x 30.5 cm x 16.5 cm) W x D x H
Weight	12.75 lbs. (5.78 kg)
BlueWave 200 Warranty	1 year from purchase
Bulb Warranty	2,000 hours (no intensity warranty during 2,000 hours, only lighting)
Replacement Bulb	38465

* For European customers, the appropriate power cord will be added. Systems shipped without a power cord shall not use power cord rated less than 10A/120 VAC or 6A/230VAC in accordance with IEC 60320.

** Measured with an EIT Spotcure Radiometer or an ACCU-CAL™ 50 Radiometer using a lightguide simulator and standard internal "Cool Blue" Filter.

Figure 49.
200W Bulb Spectral Output

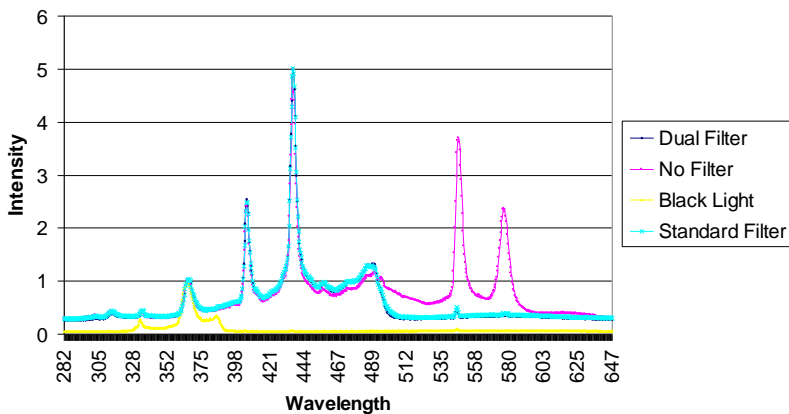

Declaration of Conformity



Declaration of Conformity

Manufacturer:
Dymax Corporation
318 Industrial Lane
Torrington, CT 06790, USA

European Address:
Dymax Europe GmbH
Kasteler Str.45
Geb.G359
Wiesbaden Germany 65203

UK Address:
Dymax
1b Hunts Grove Drive, Hardwick,
Gloucester, Gloucestershire, GL2 4BH
United Kingdom

Product description: UV Curing Device
Model name(s): BlueWave® 200 Version 3.0

This product complies with the following Directives, legal acts and standards:

- European Union Compliance (CE)
Electromagnetic Compatibility Directive (2014/30/EU):
EN 55011:2009 + A1:2010
EN 61000-3-2:2014 Class A
EN 61000-3-3:2013
EN 61326-1:2013
- Low Voltage Directive (2014/35/EU):
EN 61010-1:2010 (3rd Edition)
- RoHS Directive EU (2015/863)

Declaration:
I declare that the above information in relation to the supply and manufacture of this product is in conformity with the above standards and directives.



 3-10-2021
Name Date

Authorized Signatory:
Richard MacCutcheon
Engineering Manager
Dymax Corporation
Torrington, CT., USA

Representative in Europe:
Dominik Stephan
Director, Equipment
Dymax Europe GmbH
Wiesbaden, Germany

Representative in UK:
Kevin Westcott
Account Manager
Dymax
Gloucester, United Kingdom

www.dymax.com

Americas
USA | +1.860.482.1010 | info@dymax.com

Europe
Germany | +49 611.962.7900 | info_de@dymax.com
Ireland | +353 21.237.3016 | info_ie@dymax.com

Asia
Singapore | +65.67522887 | info_ap@dymax.com
Shanghai | +86.21.37285759 | dymaxasia@dymax.com
Shenzhen | +86.755.83485759 | dymaxasia@dymax.com
Hong Kong | +852.2460.7038 | dymaxasia@dymax.com
Korea | +82.31.608.3434 | info_kr@dymax.com

©2020 Dymax Corporation. All rights reserved. All trademarks in this guide, except where noted, are the property of, or used under license by, Dymax Corporation, U.S.A.

Definition of Terms

Bulb - Light source generating ultraviolet, visible, and infrared radiant energy from burning matter stimulated by electrical power conditioned by a proper power supply which is an integral part of a Lamp. A light source is usually placed into a Reflector (of various geometry) to increase light source efficiency by collecting and directing radiant energy of selected spectra (for a given curing process).

Intensity - A measure of light energy over the unit of surface area (usually surface at the specified working distance from the bottom of Reflector Housing) in W/cm^2 or mW/cm^2 . For the UV portion of light, this measure is often called in literature "irradiance", i.e. radiant energy arriving at a point on a surface per unit area.

Brightness, also known as **Luminance** - Description of energy in the visible region of the spectrum (approximately from 400 to 700 nm) and recorded in photometric units. "Intensity" (see below) of visible light energy is called Luminance.

Luminance - Luminous flux (energy of visible light) incident per unit area, and measured in **Lx** (lux) or **Lumen/cm²**.

Ultraviolet (UV) - The invisible region of the spectrum just beyond the violet end of the visible region. Wavelength ranges in general from 1.0 to 400 nm. Dymax bulbs (burners) do not radiate energy in deep ultraviolet; there are very minute amounts below 220 nm and practically nothing can be sensed below 200 nm. This is due to the use of ozone-blocking quartz Bulb Envelope (See Ozone).

Ultraviolet A (UV-A) - UV of long wavelength from within approximately 400 to 320 nm of the spectral band (4000 to 3200 \oplus) - predominately produced by Dymax Flood Lamps.

Ultraviolet B (UV-B) - UV of medium wavelength from within approximately 320 to 280 nm - Dymax Flood Lamps produce some amount of their energy within this bandwidth.

Ultraviolet C (UV-C) - UV of short wavelength below 280 nm (we say from 280 to 200 nm) – a large amount of this energy is present in the sunlight.

Visible - Light that can be seen 400 to 700 nm.

Dose - Irradiance integrated over time, or Irradiance (W/cm^2) x Time (s) = Dose (Joules/cm²). Note: Watt is the

power that gives rise to the production of energy at the rate of 1-joule (J) per second (s).

Ozone - Oxidizing agent (O_3) produced by the action of ultraviolet radiant energy (below 185 nm) or electrical corona discharge of oxygen on air.

OSHA 1910.145: "Regulation of Accident prevention Signs and Tags" defines the following headers as:

WARNING - Used when there is a hazardous situation that has some probability of severe injury.

CAUTION - Used to indicate a hazardous situation that may result in minor or moderate injury.

NOTICE - Used to convey a message related directly or indirectly to the safety of personnel, or protection of property.

Warranty

From date of purchase, Dymax Corporation offers a one-year warranty against defects in material and workmanship on all system components with proof of purchase and purchase date. Unauthorized repair, modification, or improper use of equipment may void your warranty benefits. The use of aftermarket replacement parts not supplied or approved by Dymax Corporation, will void any effective warranties and may result in damage to the equipment.

Replacement Bulb Warranty

If the Bulb fails to ignite during the warranty period of 2,000 hours and all Bulb history cards for a specific *BlueWave 200* have been returned to Dymax, the Bulb will be replaced under warranty.

IMPORTANT NOTE: DYNAMX CORPORATION RESERVES THE RIGHT TO INVALIDATE ANY WARRANTIES, EXPRESSED OR IMPLIED, DUE TO ANY REPAIRS PERFORMED OR ATTEMPTED ON DYNAMX EQUIPMENT WITHOUT WRITTEN AUTHORIZATION FROM DYNAMX. THOSE CORRECTIVE ACTIONS LISTED ABOVE ARE LIMITED TO THIS AUTHORIZATION.

Index

- Bulb Replacement Procedure, 27
- Bulb Replacement Warning, 26
- Contact Information, 5
- Controls, 11
- Curing System Safety, 5
- Definition of Terms, 34
- Help, 5
- Intensity Adjustment, 26
- Intensity Control, 26
- Maintenance, 26
 - Bulbs, 27
 - Cleaning, 28
 - Fan Filters, 28
 - Fuse Replacement, 28
 - Lightguides, 28
- Manual Mode, 17
- Operation
 - Manual Mode, 17
 - PLC Mode, 19
 - Setting an Operating Mode, 13
 - Timer Mode, 18
 - Turning on the Unit, 12
- Operation Modes, 13
- Optional Equipment, 32
- PLC Mode, 19
 - Front Panel Emergency Stop, 25
 - Wiring the PLC Interface, 22
- Safety, 5
- Safety of UV Light
 - Bright, Visible Light, 7
 - High-Temperature Surfaces, 7
 - Ozone, 7
 - UV Exposure, 6
- Set Up, 9
- Spare Parts and Accessories, 32
- Specifications, 33
- Support, 5
- System Settings, 11
- Timer Mode, 18
- Troubleshooting, 29
 - Diagnostic Display, 31
 - Frequently Asked Questions, 30
 - PLC, 25
- Unpacking, 8
- UV Exposure, 6
- UV Light Shielding, 6
- Warranty, 35
 - Bulb Replacement Warranty, 35



www.dymax.com

Americas

USA | +1.860.482.1010 | info@dymax.com

Europe

Germany | +49 611.962.7900 | info_de@dymax.com

Ireland | +353 21.237.3016 | info_ie@dymax.com

Asia

Singapore | +65.67522887 | info_ap@dymax.com

Shanghai | +86.21.37285759 | dymaxasia@dymax.com

Shenzhen | +86.755.83485759 | dymaxasia@dymax.com

Hong Kong | +852.2460.7038 | dymaxasia@dymax.com

Korea | +82.31.608.3434 | info_kr@dymax.com

© 2018-2021 Dymax Corporation. All rights reserved. All trademarks in this guide, except where noted, are the property of, or used under license by Dymax Corporation, U.S.A.

Please note that most dispensing and curing system applications are unique. Dymax does not warrant the fitness of the product for the intended application. Any warranty applicable to the product, its application and use is strictly limited to that contained in Dymax's standard Conditions of Sale. Dymax recommends that any intended application be evaluated and tested by the user to ensure that desired performance criteria are satisfied. Dymax is willing to assist users in their performance testing and evaluation by offering equipment trial rental and leasing programs to assist in such testing and evaluations. Data sheets are available for valve controllers or pressure pots upon request. PN 41017 MAN050DA 10/25/2021