



BlueWave® QX4 V2.0 LED Spot-Curing System

Control up to Four LED Heads Independently for Greater Curing Flexibility

- One controller controls up to four LED heads
- Available in three wavelengths - 365, 385, & 405 nm
- Variable mode allows each LED head to be programmed independently
- Interchangeable/replaceable focusing lenses in 3-, 5-, and 8-mm diameters
- Efficient LED-head temperature management eliminates need for PPE
- PLC interface with 4-channel mode

The BlueWave® QX4 V2.0 is the next step in high-performance LED spot curing units. This small, versatile unit offers higher intensity, longer die life, and better PLC functionality than the previous version with all the same great benefits of LED technology. The system is comprised of a controller with an easy-to-use control interface and up to four LED heads.

The BlueWave® QX4 V2.0 is designed for flexible operation, using LEDs installed directly at the end of the head for precision light delivery. The small diameter LED heads can be mounted very close to the piece being cured, covering hard-to-reach portions of complex geometries or providing 360° cures, and providing maximum intensity via the short working distance (focused at 5 mm). With 4 independently operable channels, multiple LED heads can be combined to cover complex parts. Alternately, wavelengths can be mixed to get the best curing properties.

Curing cycles can be activated by screen, foot pedal or PLC interface, allowing the unit to be easily incorporated into automated systems. LED heads are available in 365, 385, and 405 nm and can be outfitted with 3-, 5-, or 8-mm diameter focusing lenses. LED heads and focusing lenses can be used in any combination and can be controlled through the system's constant or variable mode.

In variable mode or through the 4-channel PLC interface, each LED head (up to four) can operate independently of the others. Each can be programmed in 1% increments for specific duty cycles, creating curing profiles with many advantages in a manufacturing or R&D setting. Variable mode gives users maximum curing flexibility and control over their process. Recipe storage for up to 20 programs.



System Features & Benefits

Features	Benefits
Use one controller with up to four LED heads	<ul style="list-style-type: none"> • Provides maximum application flexibility
LED heads available in 365, 385, or 405 nm wavelengths	<ul style="list-style-type: none"> • Compatible with a variety of UV and visible light-curable materials • Wavelengths can be mixed to product optimal cure • Units can be custom configured to your curing requirements
Variable mode allows each LED head to be programmed independently	<ul style="list-style-type: none"> • Individual exposure times and intensity settings available in 1% increments for each LED head allows for maximum curing flexibility • Timer mode from 0.1 to 999 seconds
Interchangeable/Replaceable focusing lenses in 3-, 5-, and 8-mm diameters	<ul style="list-style-type: none"> • Allows tailoring of the unit to your curing requirements
Instant on-off	<ul style="list-style-type: none"> • No warm-up period • More energy efficient
Highly flexible interconnect cables with quick connect for LED heads	<ul style="list-style-type: none"> • Can be subjected to frequent movement, with small bend radius • Flexible cables are more resilient and pliable than typical lightguides • Can be daisy chained up to 10 meters for separated work stations • Easy to handle and switch LED heads
Efficient LED-head temperature management	<ul style="list-style-type: none"> • Maximized continuous operation without overheating • Comfortable hand-held operating temperature; no PPE required • Temperature monitoring assures maximum LED life
PLC interface with 4-channel mode	<ul style="list-style-type: none"> • Easily incorporated into automated systems
Enhanced full touch screen HMI	<ul style="list-style-type: none"> • Easy to use, navigate and program • Recipe storage for up to 20 programs
Cross Platform Compatibility	<ul style="list-style-type: none"> • LED heads are compatible with the BlueWave® MX-series multi-channel controllers when used with the MX-4E expansion module

Heat Control

For applications with heat-sensitive components, or exo-thermal chemistry properties, interruptions in the exposure duration can reduce the materials' and substrates thermal rise during the cure process. This isn't a concern with the BlueWave QX4 because each LED head can be programmed to a precise curing energy exposure profile to reduce the risk of substrate damage.

Depth of Cure vs. Surface Cure

Utilizing the multiple narrow bands available for the BlueWave QX4 V2.0 the perfect combination of outputs can orchestrate the perfect cure. The approach of alternating between depth of cure and surface cure LED heads can aid in the reduction of surface tack otherwise found on single wavelength LED products.

Fluorescing for Inspection

If all four LED heads are not used during parts production, a RediCure®LED head could be set to operate as a low-intensity lamp to fluoresce many Dymax products. This aids in QC inspections, resulting in higher quality finished products.

Applying the BlueWave® QX4 V2.0



Capitalize on the small diameter and length of the BlueWave® QX4 V2.0 LED heads, as well as the short, 5-mm focus distance, to get multiple LED heads around a single point.



Use by hand or fixtured. The heat removing design allows hand use with no PPE. The quick connects allow for easy switching of LED heads to change wavelengths in R&D applications.

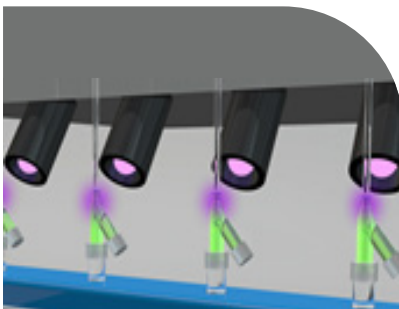

Use the 4 independently operable channels to mix wavelengths, curing times, and intensities to achieve an optimal cure. Or cure multiple pieces at one time.

LED Light-Curing Technology







Dymax LED spot-curing systems generate curing energy using high-intensity LEDs instead of conventional metal-halide or mercury-arc lamps. The relatively narrow frequency band of energy emitted by LEDs results in cooler substrate temperatures compared to traditional conventional arc lamp systems, making them ideal for curing thermally sensitive materials. Dymax LED-curing systems offer many energy and cost-saving benefits, such as no warm-up period, lower energy consumption, no bulbs to change, and more consistent frequency and intensity output for better process control.

Key Advantages of LED Light-Curing Technology

- High electrical efficiency and instant on/off capability for lower operational costs
- Long service life that eliminates bulb replacement and reduces maintenance costs
- Narrow wavelength spectral emissions that minimize substrate thermal rise
- Compact unit footprint that reduces workspace requirements and cost of the system
- Consistent frequency and intensity output for better process control
- "Green" attributes that eliminate mercury and ozone safety risks and disposal handling costs

Compatible Materials & Applications

The BlueWave QX4 V2.0 is ideally suited for a number of applications in the medical, consumer electronics, automotive, aerospace and defense, optical, and appliance industries. The chart below displays some of the materials commonly used in those industries and where the BlueWave QX4 V2.0 can be considered as a curing system.

Materials		
Adhesives		✓ Medical device (catheter, needles, tube set, facemask) assembly; glass bonding (stemware, furniture, etc.); automotive headlamp assemblies; camera module assemblies; appliance assembly; speaker assembly; optical display bonding
Conformal Coatings		✓ Printed circuit board protection in aerospace avionics, automobiles, appliances, and consumer electronics; camera module assembly; electric vehicle battery management systems
Potting Compounds		✓ Tamper proofing; potting electrical connectors, switches, and sensors; cable potting; medical potting*
Maskants		✓ Surface protection for turbine blades and rotorcraft components during processing; protection for surfaces during metal finishing processes; protection of orthopaedic parts during processing; protection of PCB components for consumer electronics, automotive electronics, avionics, and medical electronics; protection for surfaces during metal finishing processes*
Encapsulants		✓ Chip encapsulation on PCBs used in automobiles, plane and helicopter control panels, consumer electronics, appliance, and medical diagnostic equipment*
Ruggedization Materials		Flex circuit reinforcement; wire tacking; ball grid array (BGA) ruggedization; Videos graphics arrays (VGA) ruggedization; shock absorption; underfill alternative

✓ BlueWave QX4 compatible with this material

* Materials cured with BlueWave QX4 to be evaluated in customer application to their performance requirements.

System Specifications

Property	Specification
Output Frequency	RediCure® - 365 nm PrimeCure® - 385 nm VisiCure® - 405 nm
Intensity Output*	RediCure® - 16,9 W/cm ² PrimeCure® - 22,9 W/cm ² VisiCure® - 22,0 W/cm ²
Power Supply Input	100-240 V ~2 A, 50/60 Hz
LED Timer	0,1 to 999 seconds
LED Activation	Footswitch, front panel, or PLC
Cooling	Natural convection
Dimensions	Controller: 93,5 mm x 137,4 mm x 147,5 mm [3,7" x 5,5" x 5,8"] (W x H x D) LED Head: Φ 15,4 mm x 66 mm [0,6" x 2,6"] (Diameter x L)
Weight	Controller: 1 kg [2,2 lbs.] / Head: 130g [4,6 oz]
Unit Warranty	1 year from purchase date
Operating Environment	5-40°C [41-104°F], 0-80% relative humidity, non-condensing

* Measured with 3-mm lens using a Dymax ACCU-CAL™ 50-LED Radiometer, in spot mode using the BlueWave QX4 Integrated Optic Adapter

Figure 1. BlueWave QX4 Controller Dimensions

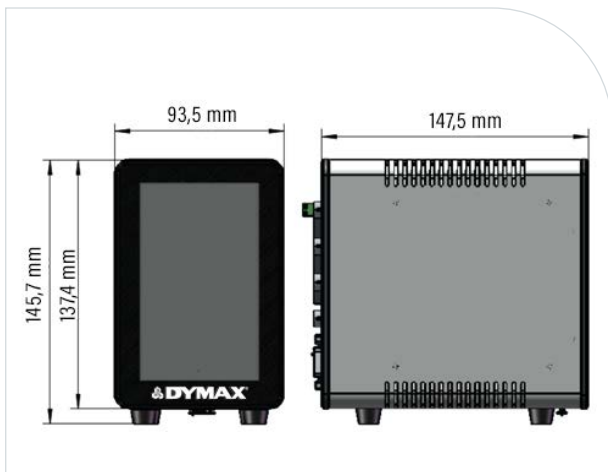
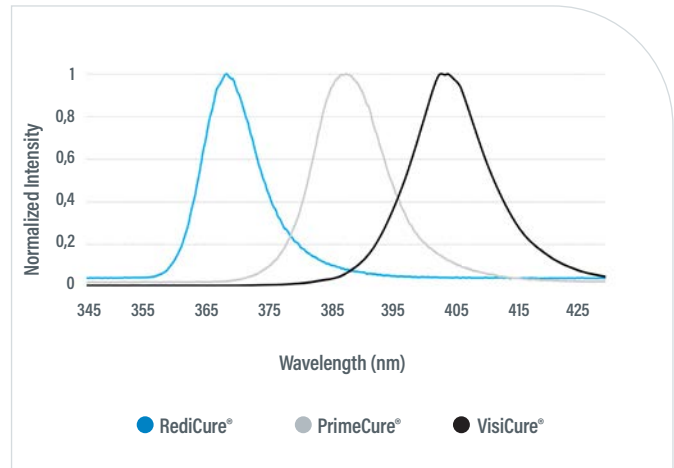
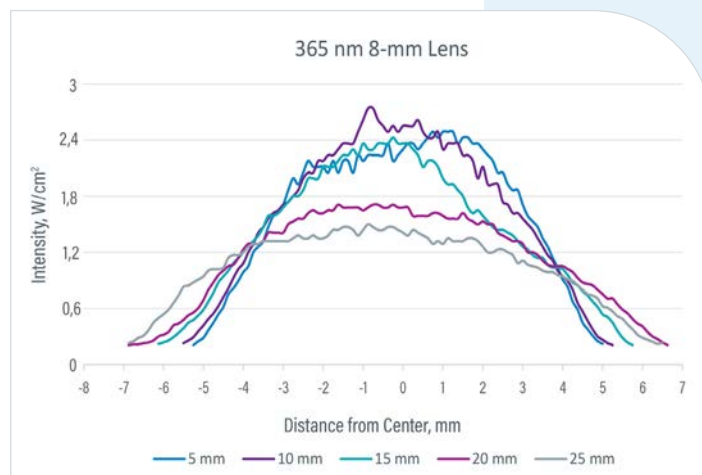
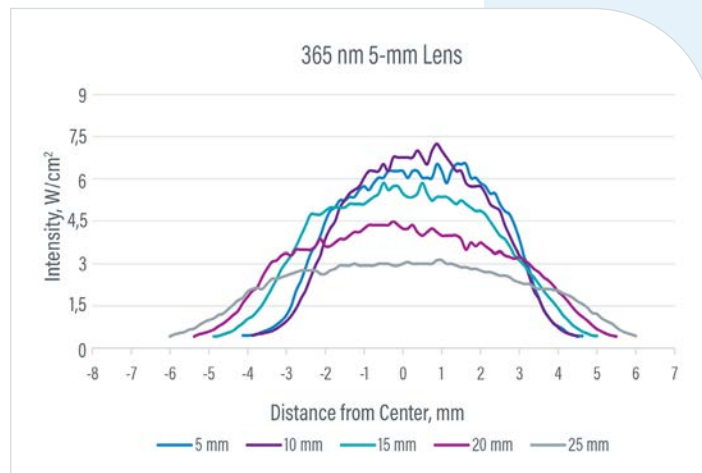
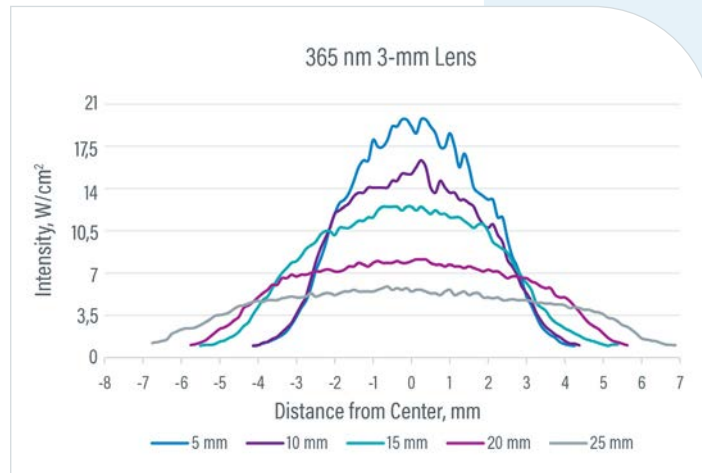

Figure 2. BlueWave QX4 Spectral Output Chart



System Intensity

Figure 3. RediCure® LED Head, 365 nm - Intensity* at Various Working Distances



Note: Curing area data taken using Fuji UV Light Distribution Mapping System and normalized to ACCU-CAL™ 50 LED Radiometer.

Figure 4. PrimeCure® LED Head, 385 nm - Intensity* at Various Working Distances

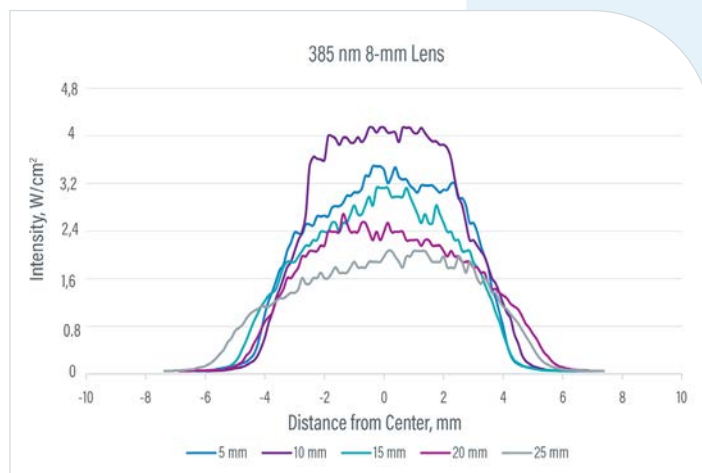
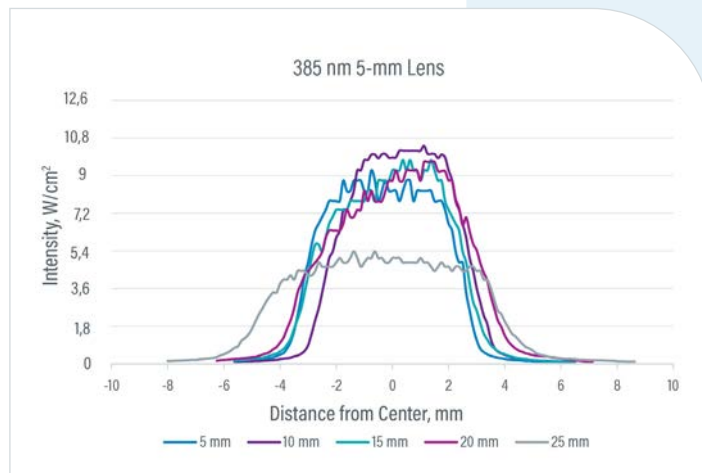
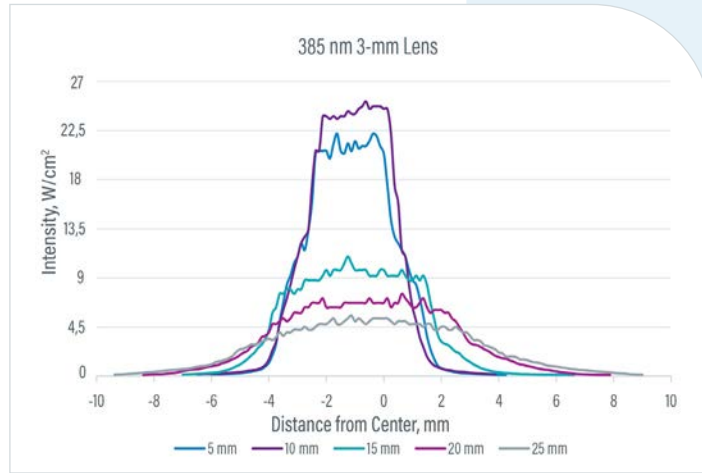

Note: Curing area data taken using Fuji UV Light Distribution Mapping System and normalized to ACCU-CAL™ 50 LED Radiometer.

Figure 5. VisiCure® LED Head, 405 nm - Intensity* at Various Working Distances

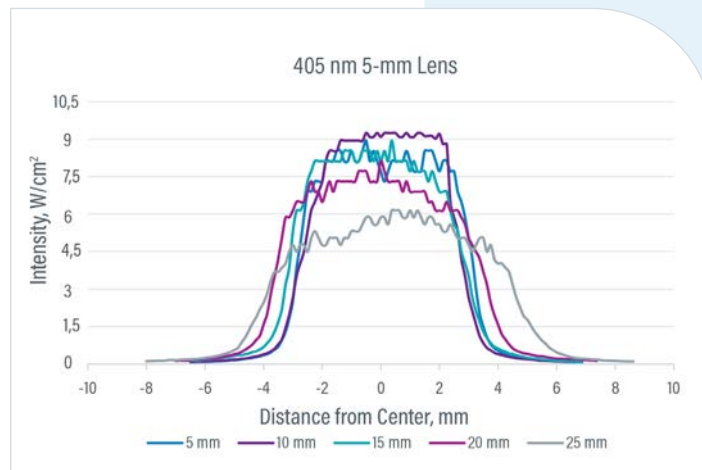
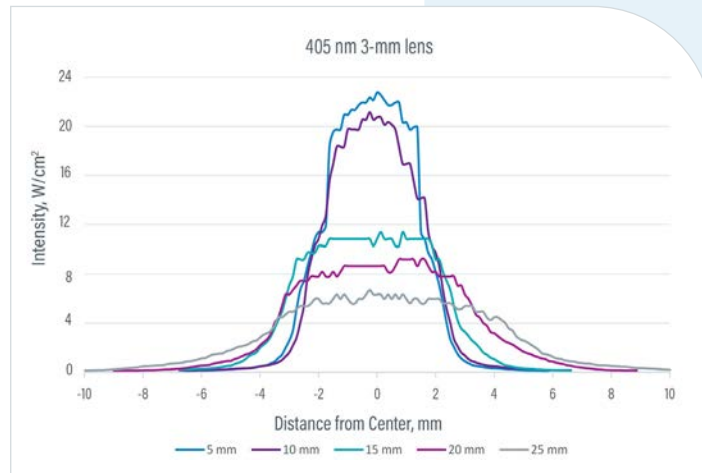

Note: Curing area data taken using Fuji UV Light Distribution Mapping System and normalized to ACCU-CAL™ 50 LED Radiometer.

Degradation/Life Testing

Unlike broad-spectrum lamps, LED curing systems do not have bulbs that require regular replacement. Instead, LED curing systems operate with high-intensity LEDs. The instant on/off functioning of LEDs greatly increases the life of these LED systems. Long-term life testing of BlueWave QX4 systems was conducted for 3000 continuous hours at 100% intensity. As noted in the graphs below, LED degradation was found to be very low for all wavelengths and intensities. Contact Dymax Application Engineering for additional details on setting up an LED curing process for maximum throughput and LED die life.

RediCure®(365 nm) Emitters

- 100% Intensity resulted in a 8% degradation per 1000 hours

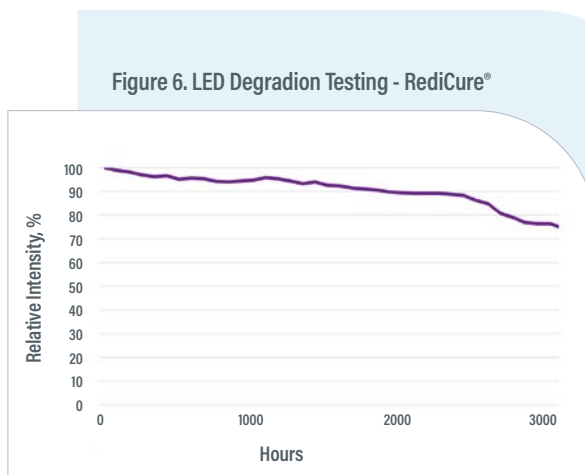

PrimeCure®(385 nm) Emitters

- 100% Intensity resulted in a 3% degradation per 1000 hours

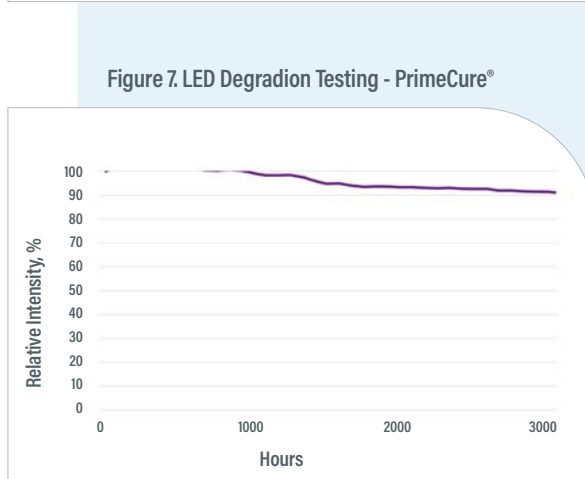

VisiCure®(405 nm) Emitters

- 100% Intensity resulted in a 3,1% degradation per 1000 hours

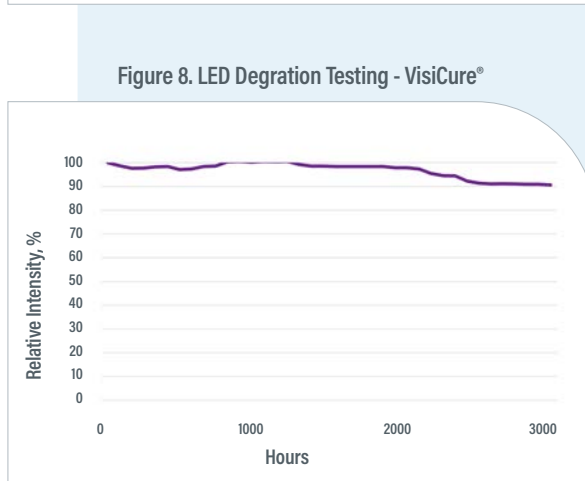

Note: Testing conducted at 70°F +/-3°F and 30% +/-10% Relative Humidity

Ordering Information

A complete BlueWave QX4 system features a controller and up to our LED heads/lenses. Each LED head must have a lens in order to operate properly. Components are sold separately.

Units are warranted against defects in material and workmanship for one year from date of purchase.

Part Numbers - Main System Components	
Controller Only	88828 No Power Cord*
	88823 China Power Cord (Type I)
	88824 North American Power Cord (Type B)
	88825 EU Power Cord (Type F)
	88826 UK/Asia Power Power (Type G)
LED Head (1 M)	88807 RediCure® 365 nm
	88808 PrimeCure® 385 nm
	88809 VisiCure® 405 nm
Lens Only	81205 3-mm Lens
	81206 5-mm Lens
	81207 8-mm Lens

* The appropriate power cord will be added for European customers.



Controller

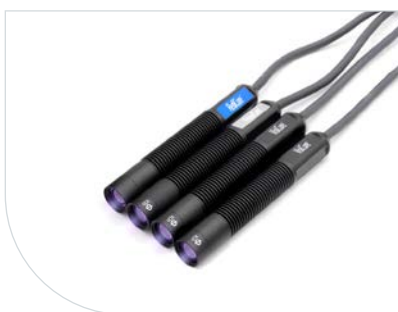

LED Heads



Focusing Lenses
Available in 3, 5, and 8 mm

Spare Parts & Accessories

Spare Parts & Accessories	
AC Power Adapter and Power Cords	<p>84103 AC Power Adapter</p> <p>84123 North American Power Cord (Type B)</p> <p>84120 EU Power Cord (Type F)</p> <p>84121 UK/Asia Power Cord (Type G)</p>
Connection Cable Extensions	<p>84125 1,0 M Extension</p> <p>84127 2,0 M Extension</p>
Stands	<p>88821 QX4 V2.0 Mounting Clamp Kit (including 81016)</p> <p>88822 Mounting Clamp Extend Rod Kit</p> <p>81016 3-Sided Acrylic Shield</p>
Radiometers	<p>40505 ACCU-CAL™ 50-LED Radiometer Kit for LED Spots, Floods, and BlueWave QX4</p> <p>42218 BlueWave QX4 Adapter Upgrade Kit (For customers who already own an ACCU-CAL 50-LED radiometer)</p> <p>Includes the integrated optic adapter, upgraded internal software, & calibration. Note: Your ACCU-CAL 50-LED must be returned to Dymax for programming.</p>
Footswitch	84124 Footswitch
Angle Adapters	81209 90° Angle Adapter for LED Head

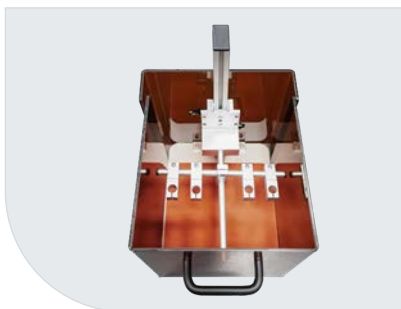

BlueWave QX4 V2.0 Mounting Clamp Kit

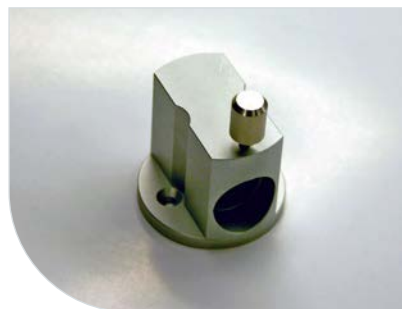

Integrated Optic Adapter

Specially designed for use with ACCU-CAL 50-LED Radiometer to test the BlueWave QX4



3-Sided Acrylic Shield



www.dymax.com

©2021-2022 Dymax Corporation. All rights reserved. All trademarks in this guide, except where noted, are the property of, or used under license by, Dymax Corporation, U.S.A.

Please note that most light-curing system applications are unique. Dymax Europe GmbH does not warrant the fitness of the product for the intended application. Any warranty applicable to products, its application and use is strictly limited to that contained in Dymax Europe GmbH's General Terms and Conditions of Sale published on our website. Dymax Europe GmbH does not assume any responsibility for test or performance results obtained by users. It is the user's responsibility to determine the suitability for the product application and purposes and the suitability for use in the user's intended manufacturing apparatus and methods. The user should adopt such precautions and use guidelines as may be reasonably advisable or necessary for the protection of property and persons. Nothing in this bulletin shall act as a representation that the product use or application will not infringe a patent owned by someone other than Dymax Corporation or act as a grant of license under any Dymax Corporation Patent. Dymax Europe GmbH recommends that each user adequately test its proposed use and application of the products before actual repetitive use, using the data contained in this bulletin as a general guide.

PB088EU 6/6/2024